

G-SERIES STYLE & MOTION

CHELSEA



AMERICAN LEATHER®

CHELSEA

Standard Features:

- Premium high-density, high-resiliency foam seat cushion and fiber filled back cushion
- Advanced unidirectional suspension system
- Semi-attached back cushions
- Semi-attached seat cushions
- Double-needle top-stitch
- In-arm control panel is easy to use and includes a USB-C charging port
- Control panel is LED backlit with auto-off after 5 seconds
- Limited lifetime warranty on frame and suspension
- Ten-year warranty on mechanism
- Three-year warranty on motor and electronics
- Quick-ship delivery

Options:

- Premium high-density, high-resiliency foam seat cushion encased in down with down blend back cushion
- Premium high-density, high-resiliency foam seat cushion encased in Trillium with Trillium filled back cushion
- Contrasting stitch detail available in Bermuda Green, Beige, Black, Brown, Charcoal, Cream, Espresso, Gold Brown, Grey, Lemon, Midnight Blue, and Scarlet thread color
- Adjustable lumbar support
- Contrasting back and seat cushions available (two-tone)
- Lithium-ion battery pack available
- Battery pack has a one-year warranty
- Easy disassembly for delivery

Please use actual leather, fabric, Crypton®, Sunbrella® and Ultrasuede® swatches when specifying furniture as the colors shown may vary due to the printing process.

NOTE: Please be advised that microfiber fabrics like SUEDELIFE and VEELIFE, and velvet fabrics such as JENSON, REED, and SURI, are not recommended for this style. For a comprehensive list of covers that are NOT suggested, please contact American Leather Support Services. This information can also be found on the fabric landing pages of our website or by scanning the swatch QR code.

Wall Clearance is 10" at full recline.

MOTION LEGEND:

- (M) = Motion
- (NM) = No motion available
- (O) = Optional motion or Stationary

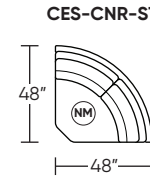
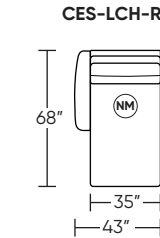
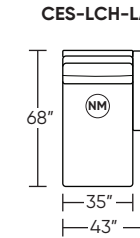
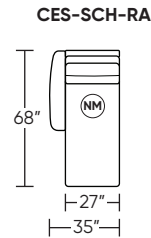
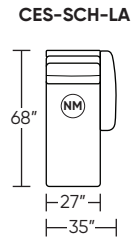
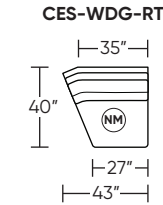
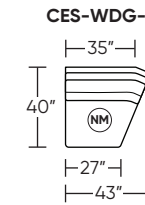
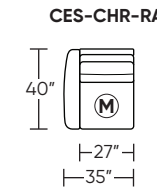
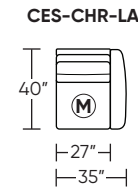
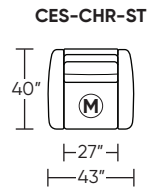
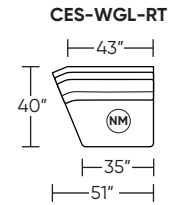
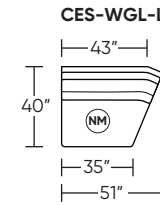
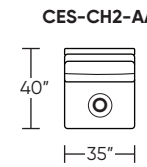
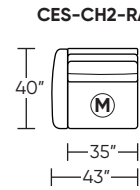
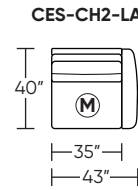
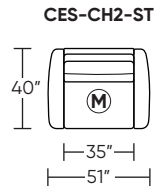
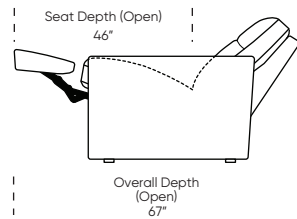
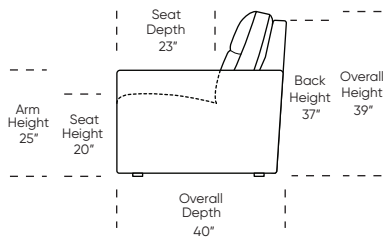

Suggested Configurations

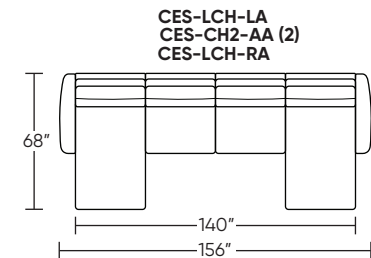
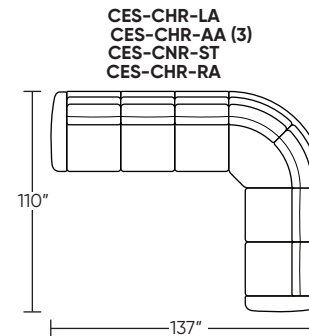
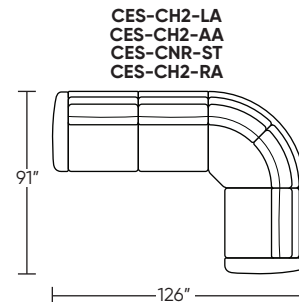
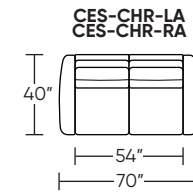
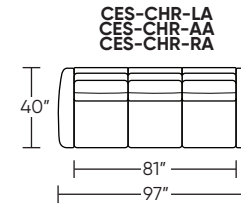
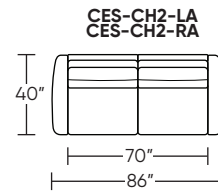

V02.09.26

Safe low voltage electrical components are UL listed.

Scale: 1/8 inch = 1 foot
All dimensions are approximate and subject to change.
Specify all components from the sitting position.