

Standard / Ottomans / Armless

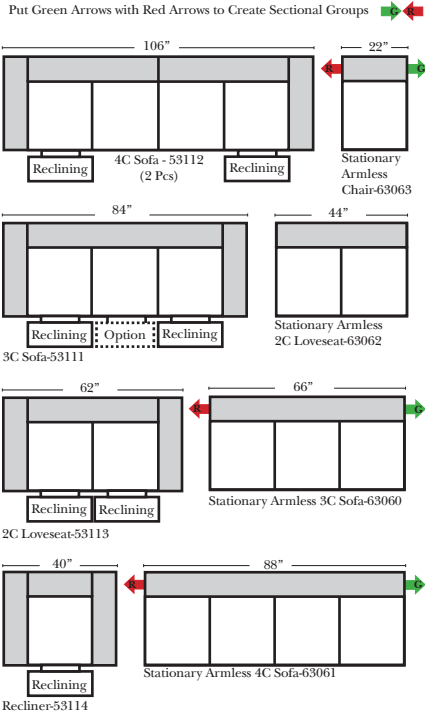

Curve Sectional

v.11.23.15

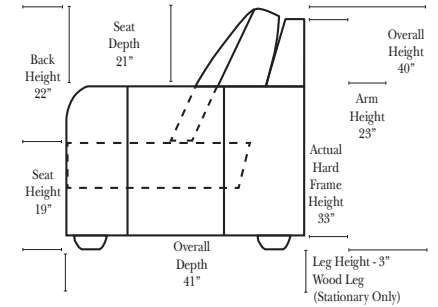
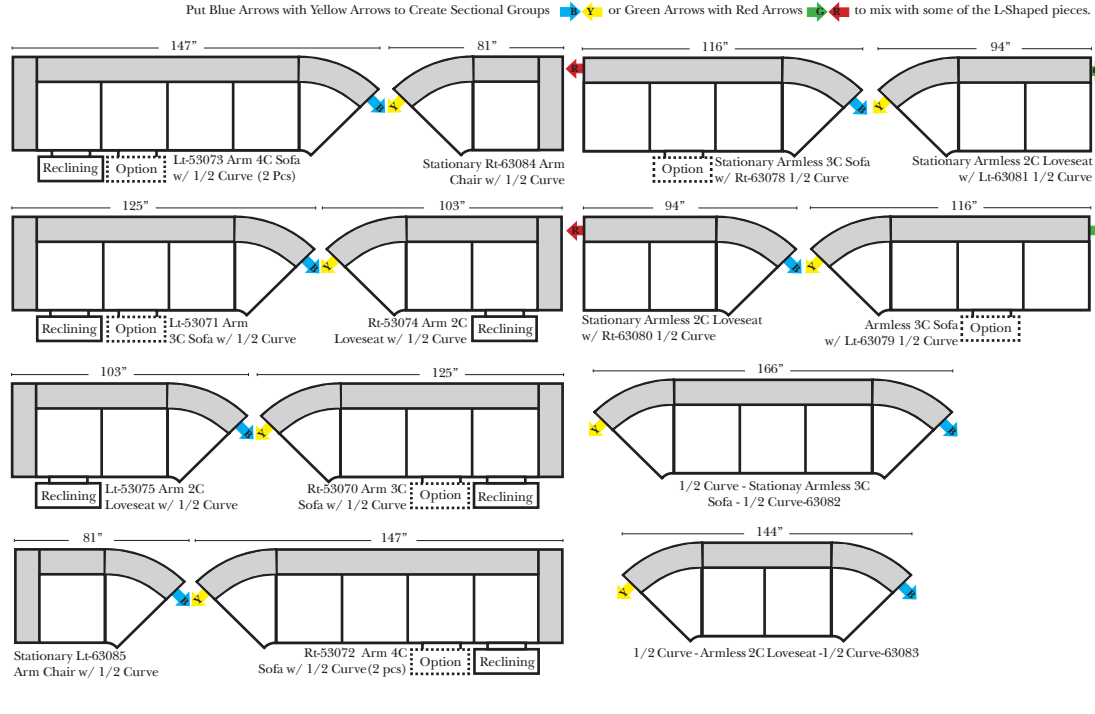

Feature & Options

Standard:

- Available in Full & Top Grain Leathers
- Available in Luxury Fabrics
- All Hardwood Frames
- Nail Heads - Brass
- Wood Leg Finish - Walnut Finish (Stationary Only)

Options Available with No Additional Charge:

- No. 33 Firm Foam
- Wood Leg - Cherry, Chocolate, Espresso, Honey Oak, Shadow

Options that have Additional Charges:

- Console Table - Standard as Espresso finish (N/C Option is Honey Oak finish)
- Metal Cup Holder (MCH) - Standard Finish is Silver (N/C Option is Black or Hammered Antique Finish)
- Electronic Cup Holder (ECH) Console Arms Only (Available with Motorized Reclining Seats only)
- Sofa Center Recliner (Additional Charge)
- Motorized Recliner Mechanism (additional Charge)
- Swivel Recliner Base (additional Charge)
- Swivel Glider Mechanism (additional Charge)
- Lift Chair Dual Motor Mechanism (additional Charge)

Sleeper Options: (Additional charges apply)

- Full Sleeper available w/Standard Mattress
- Deluxe Innerspring Mattress: Full
- Air Dream Coil Mattress: Full Only

All items on these pages are available as Stationary (Non-Reclining)

90 Degree / L-Shape Sectional

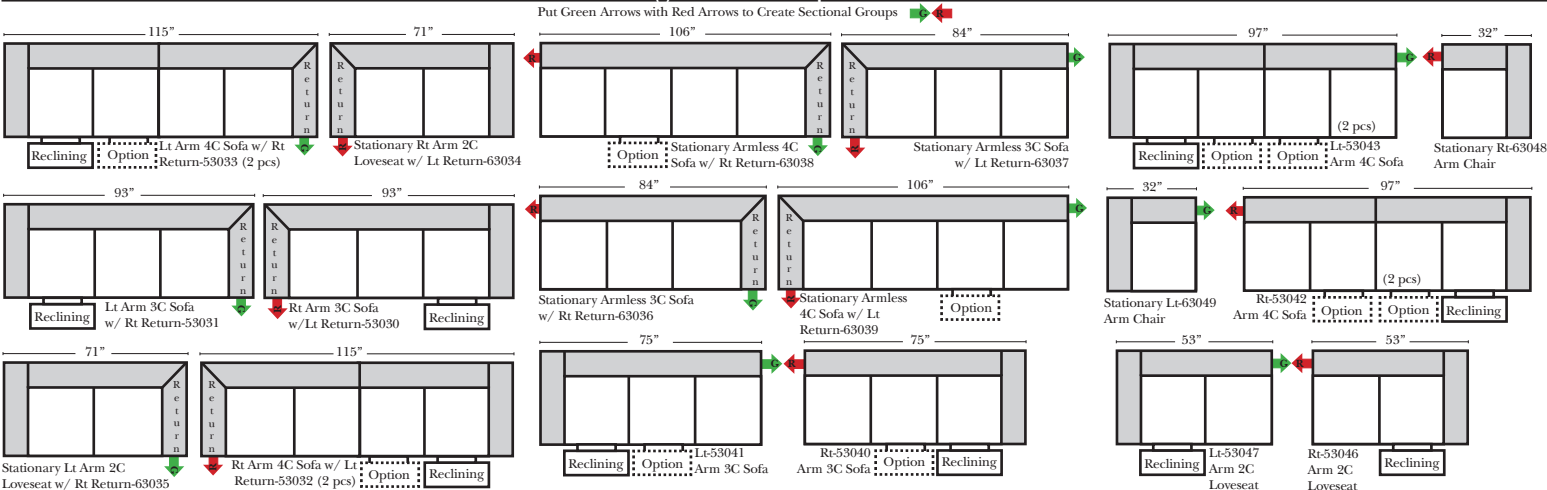

Note:

All Dimensions are approximate, if accuracy is crucial, please contact us for validation of the dimensions shown. However, a 1" to 2" variance can still apply due to foam and upholstery.

Conversation Sectional / Chaise

Put Green Arrows with Red Arrows to Create Sectional Groups
Put Orange Arrows with Tan Arrows to Create Sectional Groups

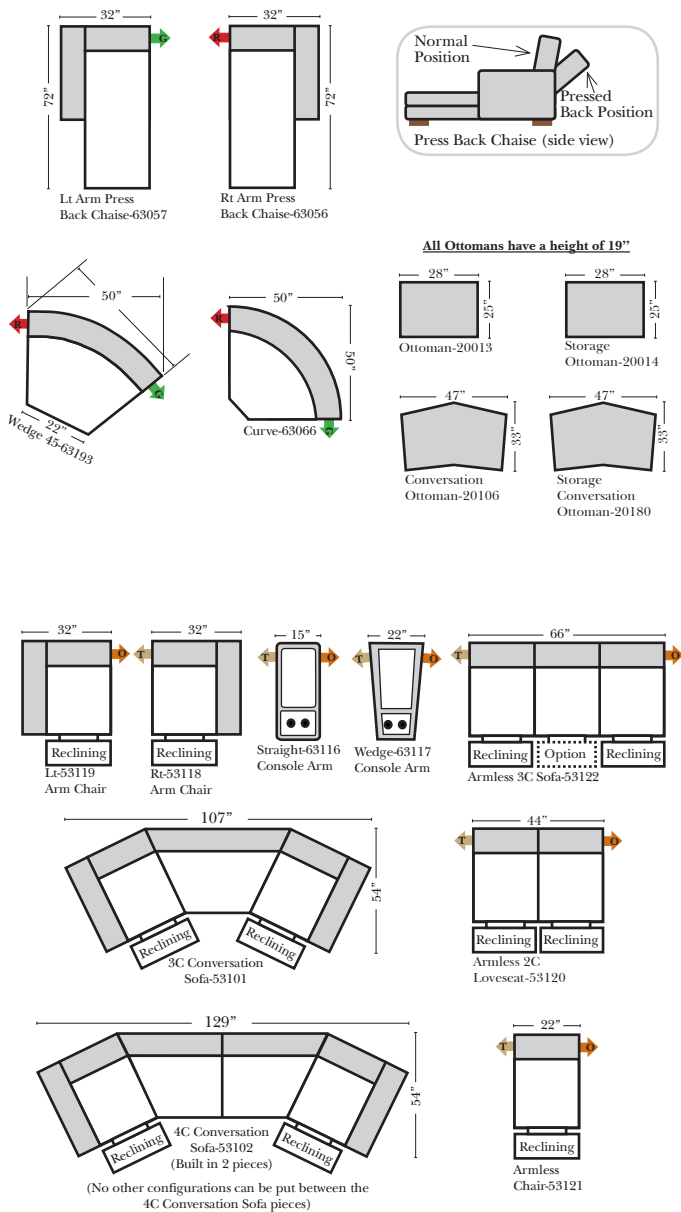

Sleepers

Put Blue Arrows with Yellow Arrows to Create Sectional Groups

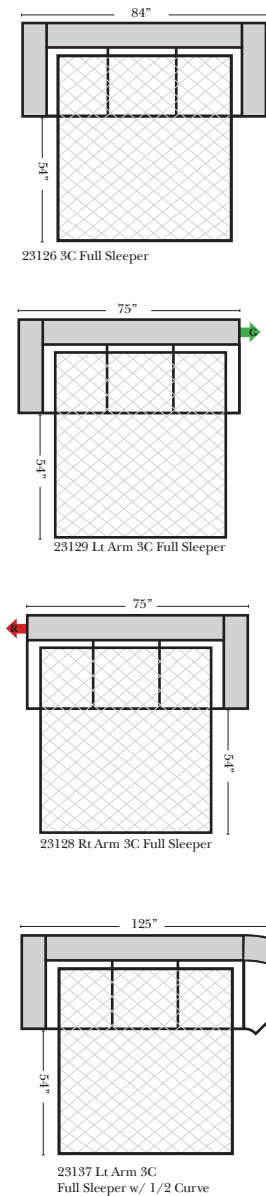

Suggested Configurations

v.11.23.15

The Suggested Configurations below are only a sample of what the imagination can create, please enjoy creating the configuration that fits your lifestyle, using the ideas below and from the items on the opposite page.

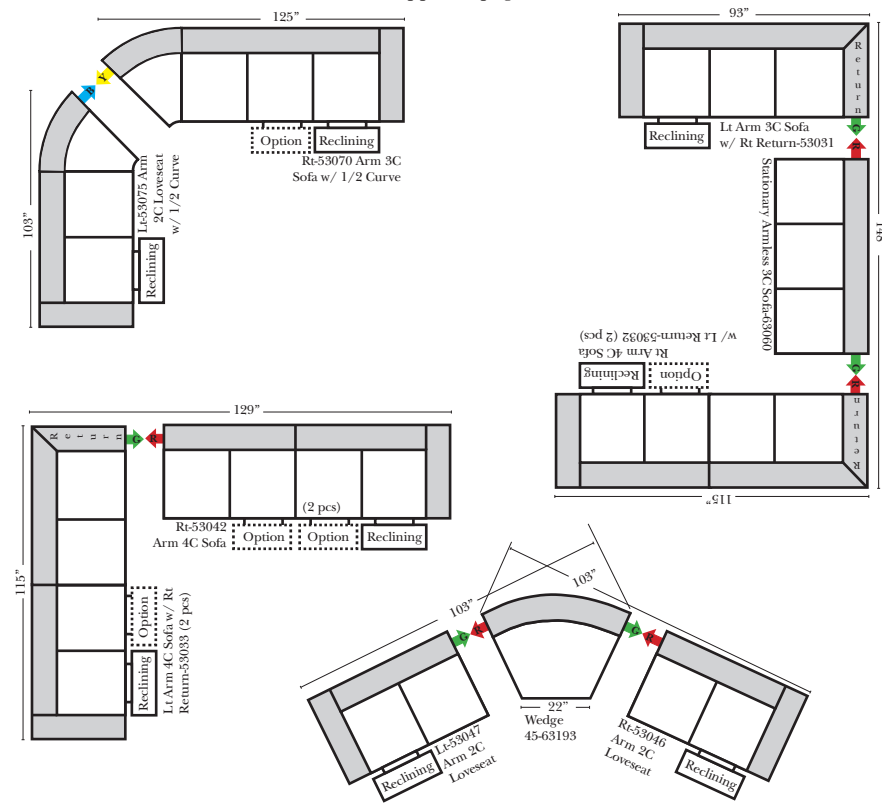

Sleepers (cont.)