

Standard & Armless (All 4 seat items ship as one piece if stationary)

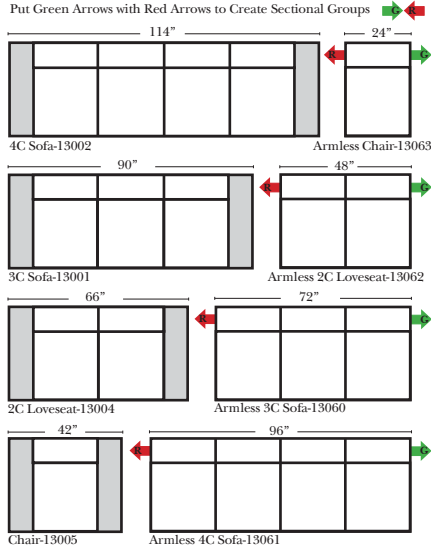

2 Piece Curve Sectional & Ottomans

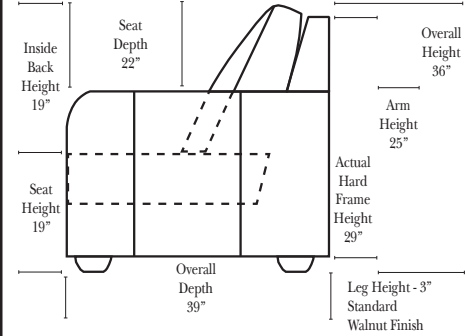
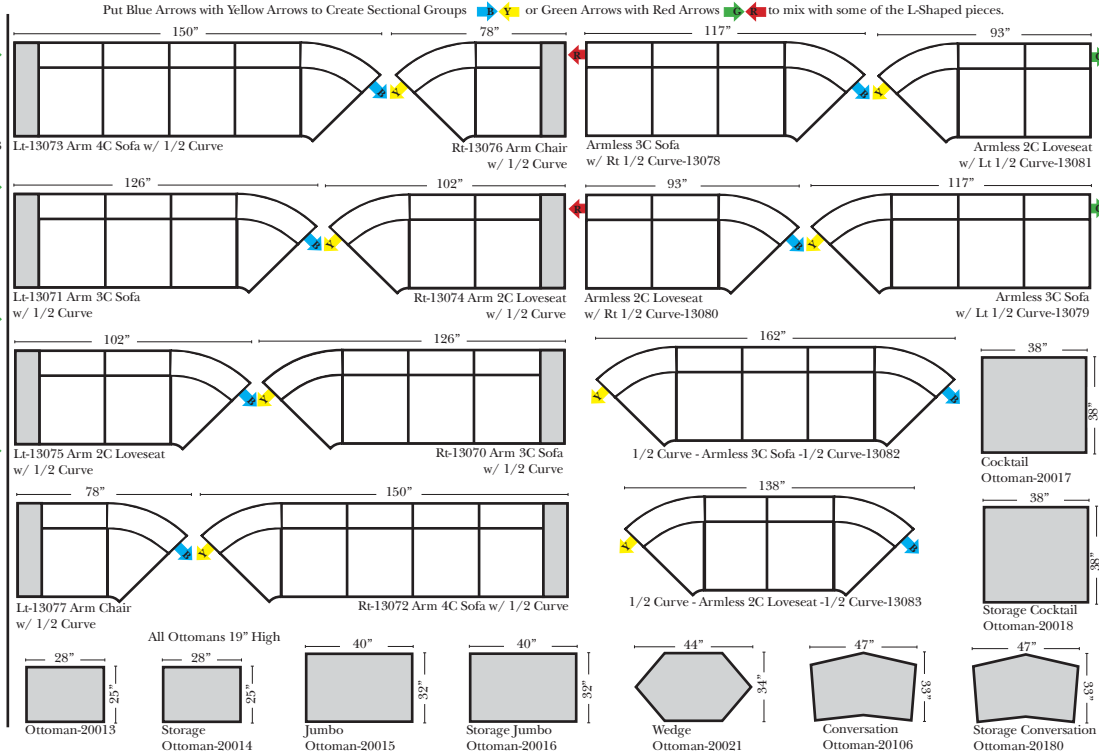

- Standard & options**
- Standard:**
- Available in Full & Top Grain Leathers
 - Available in Luxury Fabrics
 - All Hardwood Frames
 - Nail Heads
 - Legs are standard as Walnut Finish
- Options: (No Additional Charge)**
- No. 33 Firm Foam Cushions
 - Wood Leg Finish (Available in Cherry, Chocolate, Espresso, Honey Oak, & Shadow)
- Options: (additional Charge)**
- Down Seats & Backs
 - Upholstered Swivel Base (2 arm Chair Only) (Not available on Chair & 1/2 if Available)

L-Shape / 90 Degree Sectional (All 4 seat items ship as one piece if stationary)

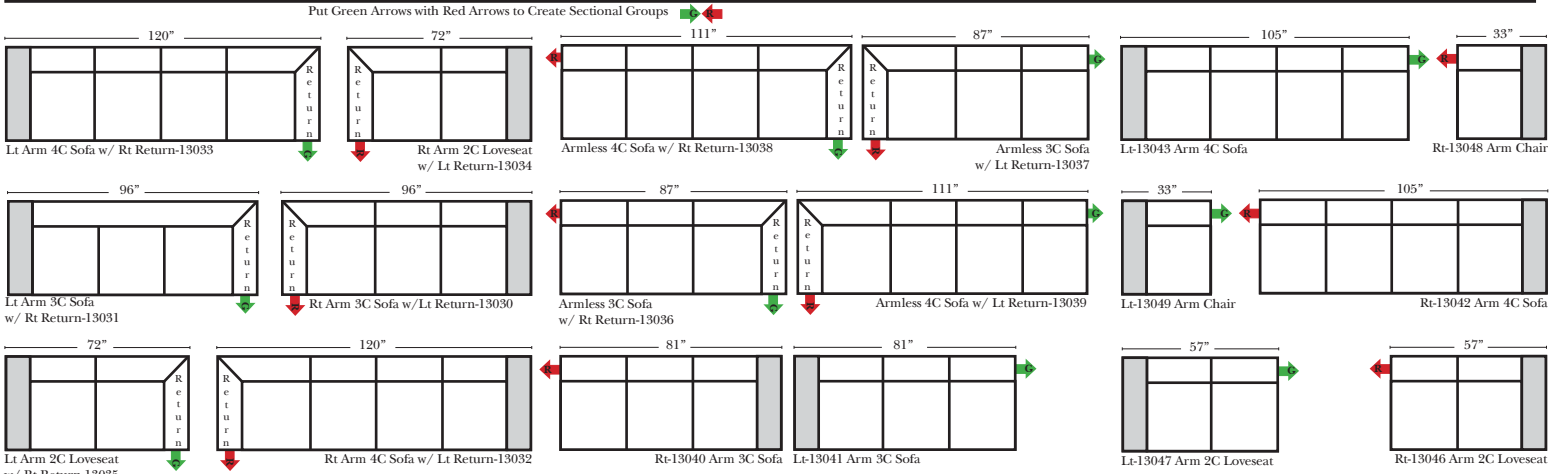

- Sleeper Options: (All the below options are at additional charges)**
- Queen Sleeper available w/ Deluxe Mattress
 - Twin Sleeper available w/ Deluxe Mattress
 - 5" Memory Foam Mattress: Queen/Twin
 - Hideaway Air Mattress: Queen Only (Shipped in a Separate Box)



Note:
All Dimensions are approximate, if accuracy is crucial, please contact us for validation of the dimensions shown. However, a 1" to 2" variance can still apply due to foam and upholstery.

Chaise & Conversation Sectionals

Put Green Arrows with Red Arrows to Create Sectional Groups
Put Orange Arrows with Tan Arrows to Create Sectional Groups

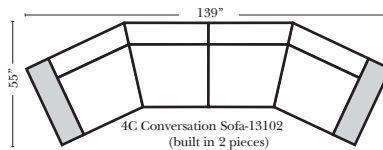
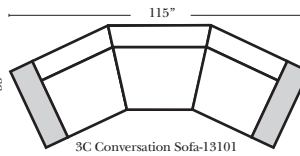
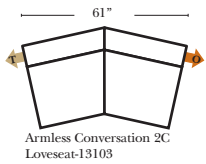
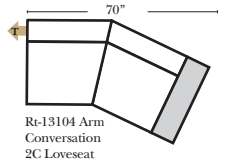
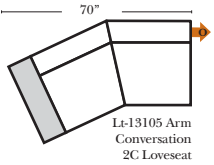
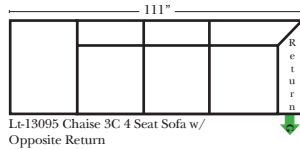
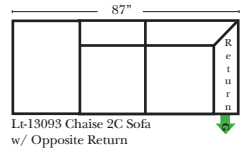
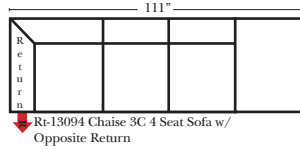
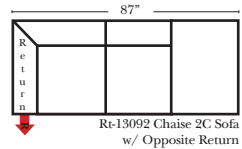
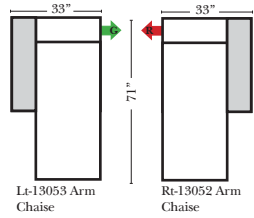

Sleepers

Put Green Arrows with Red Arrows to Create Sectional Groups
Put Blue Arrows with Yellow Arrows to Create Sectional Groups

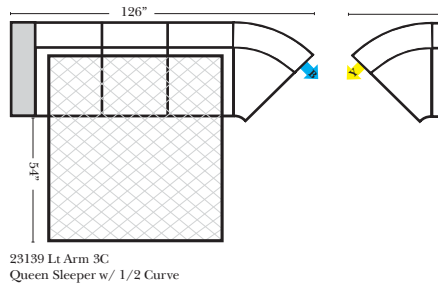
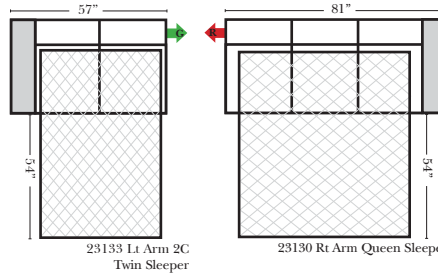
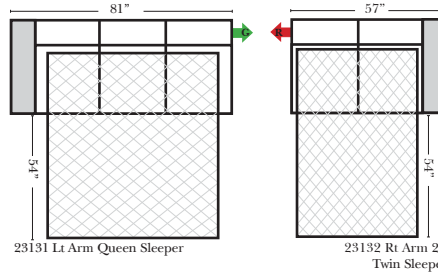
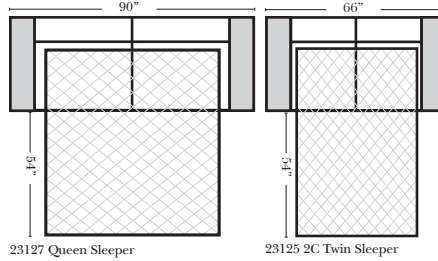

Suggested Configurations

11/16/2018

The Suggested Configurations below are only a sample of what the imagination can create, please enjoy creating the configuration that fits your lifestyle, using the ideas below and from the items on the opposite page.

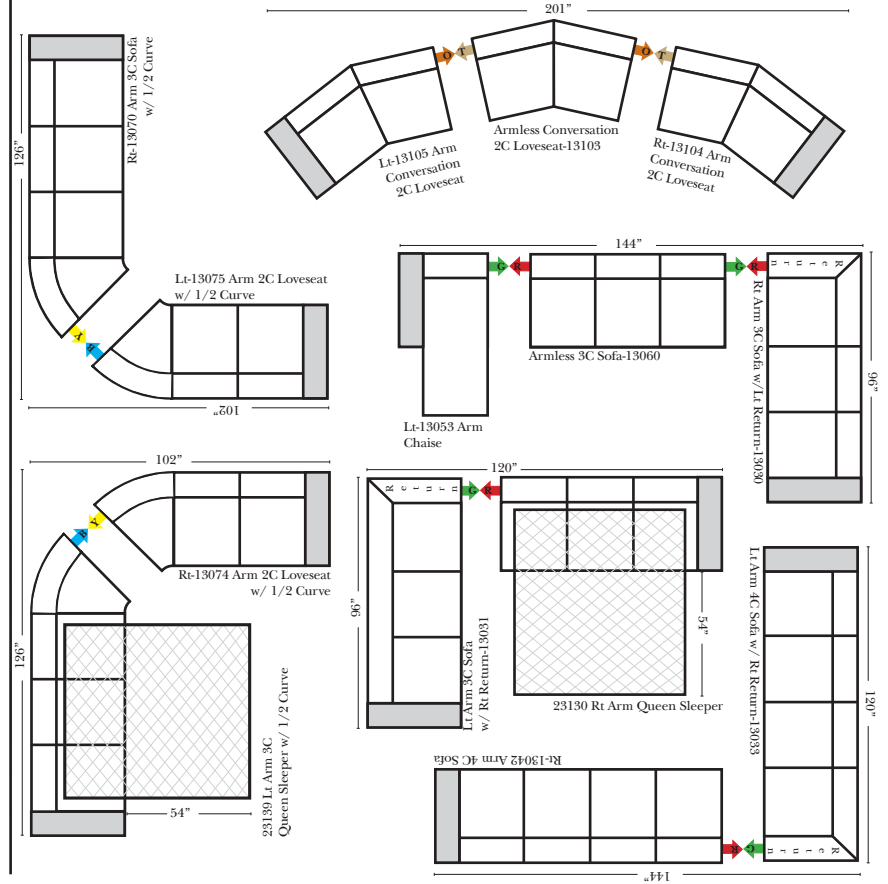

Sleepers (Cont.)

