









**Hardware List**

1		28PCS 5/16" Flat Washer	4		4PCS 1/4"x1-1/2" Machine Bolts
2		28PCS 5/16" Spring Washer	5		4PCS (1-1/2") Flat Head Wood Screws
3		28PCS 1/4"x3/4" Machine Bolts	6		4PCS Metal Plates

**Parts List**

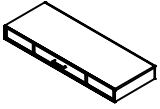
A	TABLE TOP	1 PC	B	LEGS	4 PCS	C	TRIANGLE BLOCKS	4 PCS
								

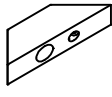
Caution: Please read instructions thoroughly before unpacking assembly parts. Sharp, exposed staple tips can cause injury, therefore, for your protection, please remove any exposed staples used in packing.

Please keep all hardware parts out of the reach of children.

1. We recommend that you should assemble this product with the assistance of another person; this will make assembly easier, and will help to eliminate damage to the product or injury to persons during assembly.
2. Be sure to check all packing materials carefully for small parts that may have come loose inside the carton during shipment.
3. Please do not over tighten screws or bolts.
4. Please put all parts on a non-abrasive floor before assembly, and follow the assembly steps to assemble your newly purchased product correctly and efficiently.

**STEP (1) : Attach Table Leg (B) to Metal Plates (6) using Washer (1), Spring Washer (2) and (3/4") Machine Bolts (3) .**

**STEP (2) : Turn Table Top (A) upside down on a soft protective surface such as a carpet. Attach Table Leg (B) to Table Top (A) using Washer (1), Spring Washer (2) and (3/4") Machine Bolts (3) .**

**STEP (3) : Attach Triangle Blocks (C) to Table Top (A) and Table Leg (B) using (1-1/2") Machine Bolts (4) and (1-1/2") Round Head Wood Screws.**

Once the Writing Desk is fully assembled, lift it up completely off the ground and turn to upright position. Avoid applying weight on the legs while turning the table. Assembly is now complete. Thank you for your purchase.

Step 3

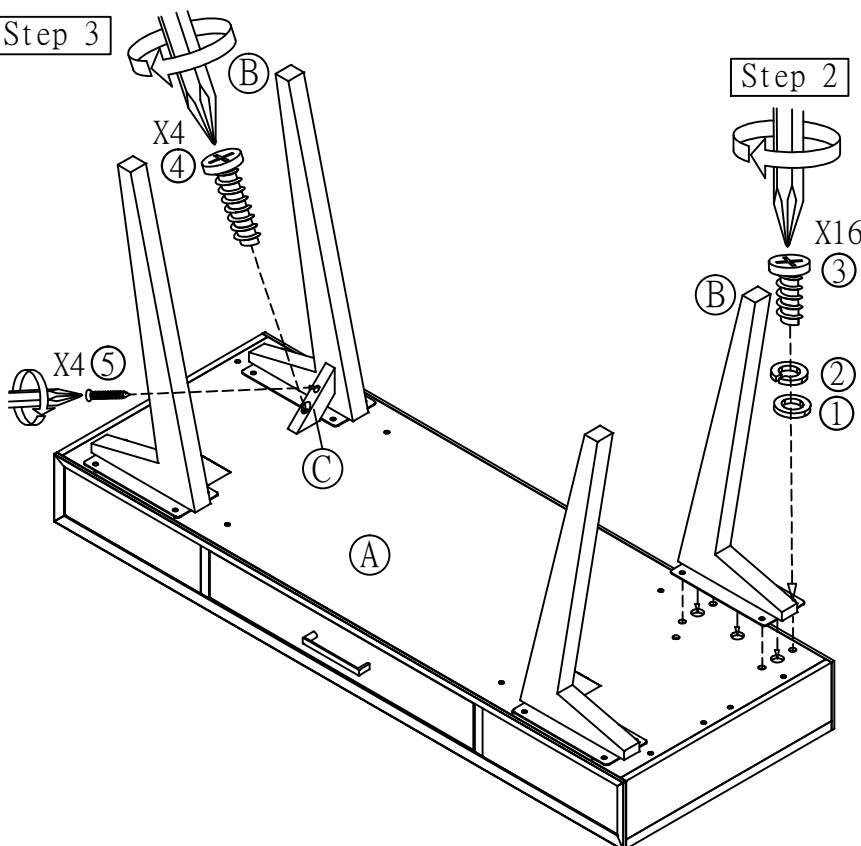

Step 2

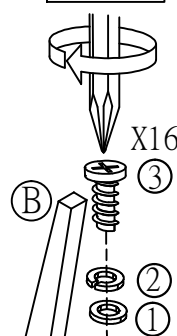

Step 1

