







Hardware List

| | | | | | | | |
|---|---|---------------------------|--------|---|---|-----------------------------|--------|
| 1 |  | 1/4"x1-1/4" Machine Bolts | 12 PCS | 2 |  | 7/8"Sharp end screws | 26 PCS |
| 3 |  | Shelf Clips | 16 PCS | 4 |  | 3/4" Sharp end screws | 16 PCS |
| 5 |  | Connection plate | 1 PCS | 6 |  | 1/2" Round flat-head screws | 2 PCS |

Parts List

| | | | | | | | | |
|---|--------------------|-------|---|------------------|------|---|-----------------|------|
| A | TOP | 1 PC | B | Right Side Panel | 1 PC | C | Left Side Panel | 1 PC |
|  | | |  | | |  | | |
| D | Fixed Shelf | 1 PC | E | Bottom Panel | 1 PC | F | Back Panel | 1 PC |
|  | | |  | | |  | | |
| G | Adjustable shelves | 4 PCS | | | | | | |
|  | | | | | | | | |

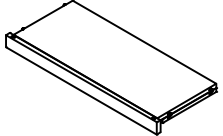
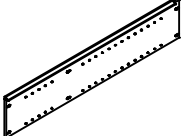
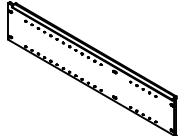
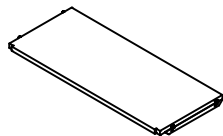
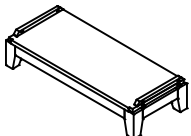
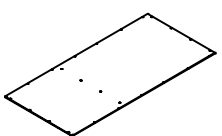
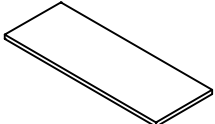
Step1:

Place the bottom panel (E), fixed shelf (D) and top (A) front facing down on a non abrasive surface.

Insert ①(2PCS) through the (E) to connect right side panel (B). Then insert ①(2PCS) through the fixed shelf (D) to connect the right side panel (B) and ①(2PCS) to connect the top (A) and the right side panel (B). do the same procedure to the left side panel (C).

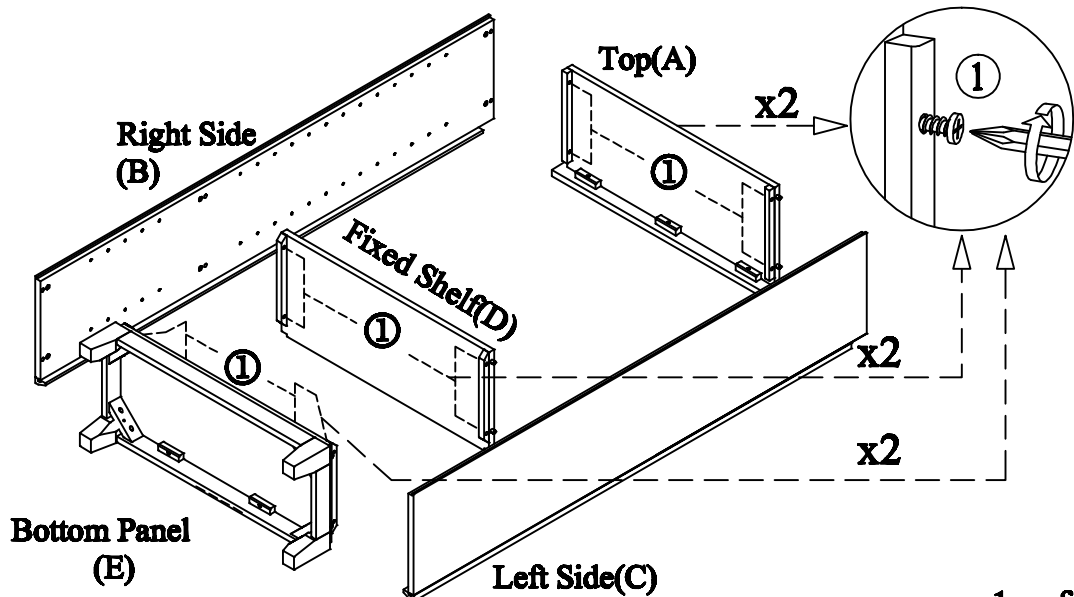

Step2:

Place the back panel (F) over the bookcase. with finish facing down. once the back panel (F) is aligned insert ②(26 PCS) through the predrilled holes to connect the bookcase.

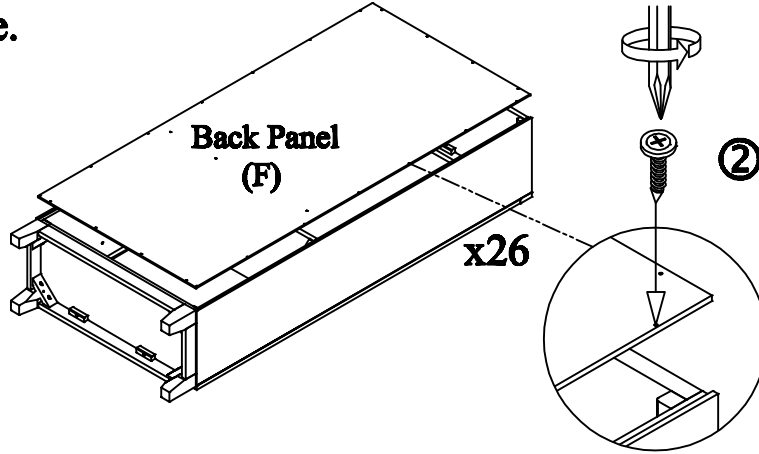

Step 3.

Locate the desired position of the shelves, insert shelf clips in corresponding holes. Place Adjustable shelves (G) on shelf clips and fasten with 3/4" sharp end screws using a phillips head screwdriver.

Caution:For safety purpose please install the tip restraint kit.

Note:connecting plate goes here

