

# WINNERS

ONLY INC.

## ASSEMBLY INSTRUCTIONS







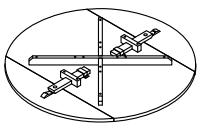

Thank you for purchasing this quality product. Be sure to check all packaging materials carefully for small parts that may have come loose inside the carton during shipment.

**Reminders**

1. Use only the hardware supplied.
2. Do not over-tighten bolts.
3. This item may require periodic tightening.

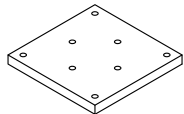
**ITEM NO : DFB14040T**  
**DFB14040B**  
**DZ14040T**  
**DZ14040B**

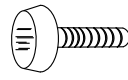
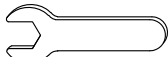
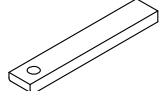
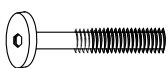
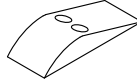
**Hardware List :**

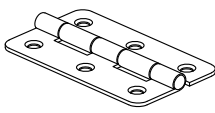
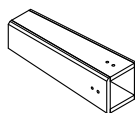
COMPONENTS LIST DFB14040T			QTY	NO	DESCRIPTION	SIZE	FIGURE	QTY
A	Table Top		1pc	1	Flat Washer	Ø5/16"x 19mm		12pcs
B	Table Legs		4pcs	2	Spring Washer	Ø5/16"x 12mm		12pcs
C	Mounting Plate		1pc	3	Hex- Nut	Ø5/16"x 12mm		8pcs
F	Adjustable Leveler		4pcs	4	Wrench	75x 12mm		1pc
G	Glides		2pcs	5	Long Bolt	Ø1/4"x 64mm		4pcs
H	Plastic Separation blade		2pcs	6	Allen Key	58x 23x 4mm		1pc
I	Leaf Hinge		6pcs	<b>COMPONENTS LIST DFB14040B</b>				
J	Post		1pc					

**TIP:** store the Allen key and or Wrench used in assembly in this product's drawer or use masking or painter's tape to affix it to the underside of the product. This will make it easier to find if you want to periodically tighten bolts or disassemble the product.

**IMPORTANT NOTE:**

- Please keep all hardware parts out of the reach of children.
- Two or more people are needed for assembly.

# WINNERS

ONLY INC.

## ASSEMBLY INSTRUCTIONS

ITEM NO : DFB14040T  
 DFB14040B  
 DZ14040T  
 DZ14040B

**STEP 1:**  
 Attach Mounting Plate (C) to the Post (J) insert Flat washer (1), spring washers (2), hex- nut (3), tighten by using wrench (4).

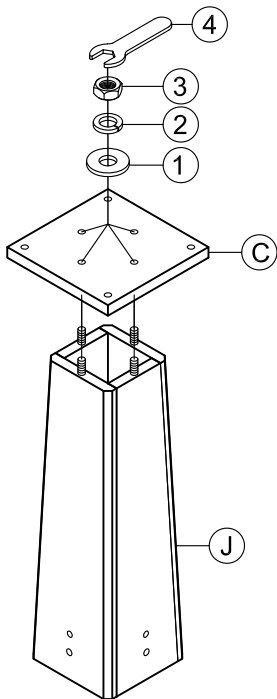

**STEP 2:**  
 Attach Mounting Plate (C) to the Table Top (A), insert long bolts (5), spring washers (2), flat washers (1), tighten by using allen key (6).

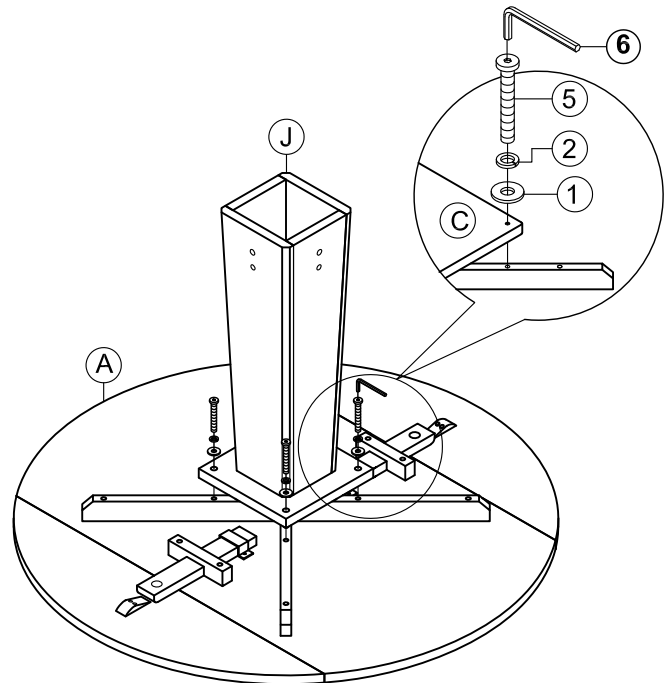

**STEP 3:**  
 Attach Table Leg (B) to the Post (J) insert Flat washer (1), spring washers (2), hex- nut (3), tighten by using wrench (4).

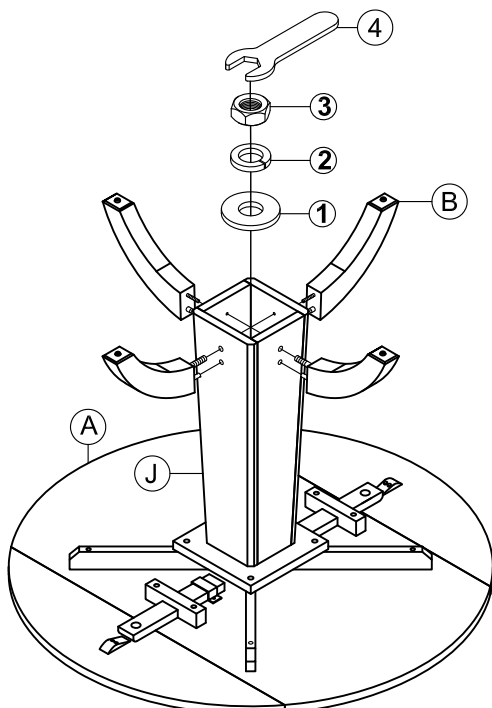

**STEP 4:**  
 Remove the screws from each glide, so the glides can slide inwards allowing the leaves to drop down properly.

