

# WINNERS ONLY®

## ASSEMBLY INSTRUCTIONS

PROD. NO: DST545024

Thank you for purchasing this quality product. Please read instructions thoroughly before unpacking the assembly parts.





Caution : Sharp exposed staple tips can cause injury, therefore for your protection, please remove any exposed staples used in packing.

Please keep all hardware parts out of the reach of children.



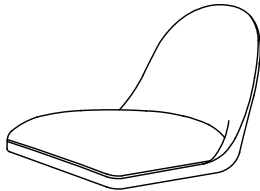

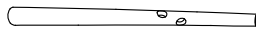
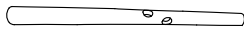
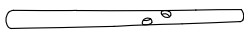
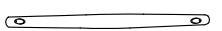
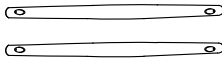
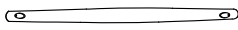
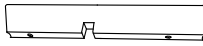
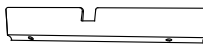
1. We recommend that you should assemble this product with assistance of another person; this will make the assembly easier, and will help to prevent personal injury and to insure parts are not damaged during the assembly process.
2. Before beginning, please check the packing materials carefully for small parts which may have come loose inside the carton during shipping. Please do not discard any packing material until all parts have been located. If any parts are missing, please contact your dealer for prompt replacement.
3. To prevent damage to your floor or carpet, please check the bottom of each piece of furniture for stain residues and rough surfaces and also check for staples or nails left after removing the packing materials. The manufacturer will not be held responsible if preventive steps are not taken prior to installation.
4. Please do not over tighten screws or bolts. During normal use everyday, screws, bolts, nuts and wooden plugs may loosen up. They should be periodically inspected and re-tightened to prevent damage to the furniture and (or) personal property or cause injury. Always check to be sure all hardware on this list and the below mentioned components are attached to the furniture properly and kept tightened.
5. Please lay all parts and hardware on a non abrasive surface such as a carpet, and follow the assembly.

This product will take 15-20 minutes to assemble

### Components List:

NO	DESCRIPTION	SKETCH	QTY
A	CUSHION SEAT		1 PC
B	FRONT LEG (RIGHT)		1 PC
C	FRONT LEG (LEFT)		1 PC
D	BACK LEG (RIGHT)		1 PC
E	BACK LEG (LEFT)		1 PC
F	BACK STRETCHER (SHORT)		1 PC
G	SIDE STRETCHER (MEDIUM)		2 PCS
H	FRONT STRETCHER (LONG)		1 PC
I	CROSS BAR (UPPER)		1 PC
J	CROSS BAR (LOWER)		1 PC
K	CORNER BLOCK		3 PCS

### Hardware List:

NO	DESCRIPTION	SIZE	SKETCH	QTY
1	JCBC BOLT WITH WASHER	5/16" X 50mm		4 PCS
2	JCBC BOLT WITH WASHER	M6 X 70mm		4 PCS
3	WOODEN SCREW	M5 X 32mm		8 PCS
4	WOODEN SCREW	M4 X 20mm		6 PCS
5	ALLEN KEY	M4		1 PC

Screw driver is require for assembly (not included)

**TIP:** store the Allen key and or Wrench used in assembly in this product's drawer or use masking or painter's tape to affix it to the underside of the product. This will make it easier to find if you want to periodically tighten bolts or disassemble the product.

# WINNERS ONLY®

## ASSEMBLY INSTRUCTIONS

PROD. NO: DST545024

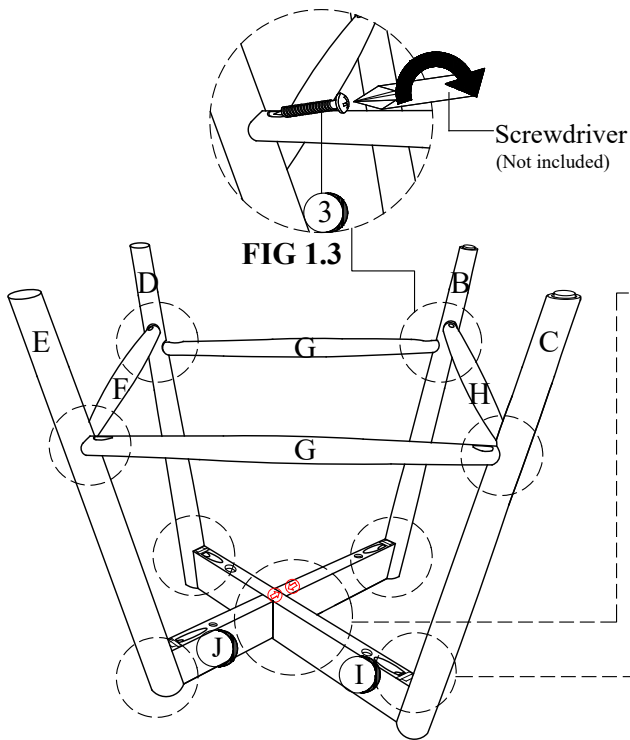

FIG 1.3

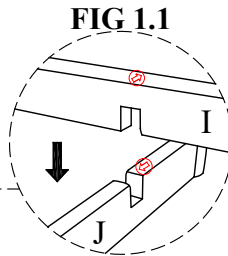

FIG 1.1

**Step 1.1** Attach Cross bar upper (I) to Cross bar lower (J) as shown on FIG 1.1

**Step 1.2** Attach all legs (B,C,D,E), insert the JCBC Bolt with washer (1) into the pre-drilled holes on the Cross bar (I, J) into the Leg, tighten the JCBC Bolt with washer with Allen Key provided as shown on FIG 1.2

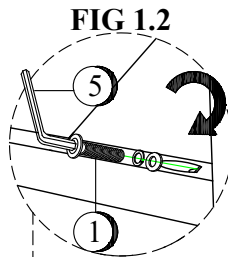

FIG 1.2

**Step 1.3** Secure all Stretchers (F,G,H) to Legs, using Wooden screw (3), tighten them with Screwdriver as shown on FIG 1.3

**Step 2.1** Insert the JCBC Bolt with washer (2) into the pre-drilled holes on the Cross bar (I, J) into the Cushion seat (A), tighten the JCBC Bolt with washer with Allen Key provided as shown on FIG 2.1

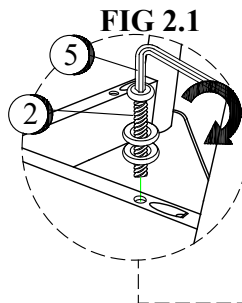

FIG 2.1

**Step 2.2** Attach Corner block (K) on front and both sides of the Cushion seat (A) using Wooden screws (4), tighten them with Screwdriver as shown on FIG 2.2

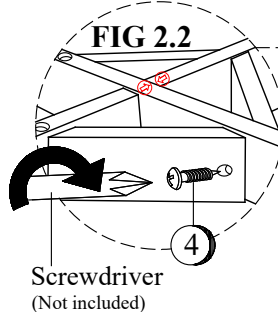
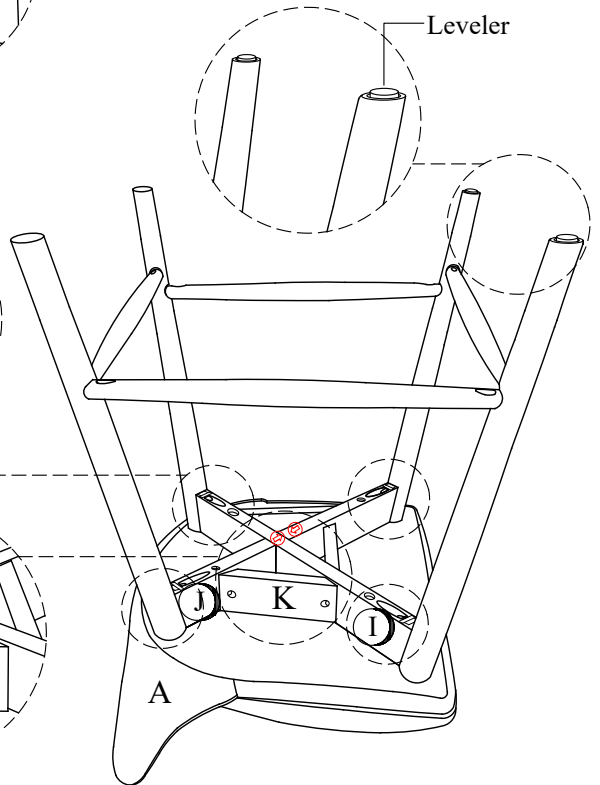

FIG 2.2

Screwdriver  
(Not included)



Leveler

**Step.3** Turn the chair to a standing position.

**Step.4** Check the chairs balance and tighten all the screws and bolts to complete the assembly.

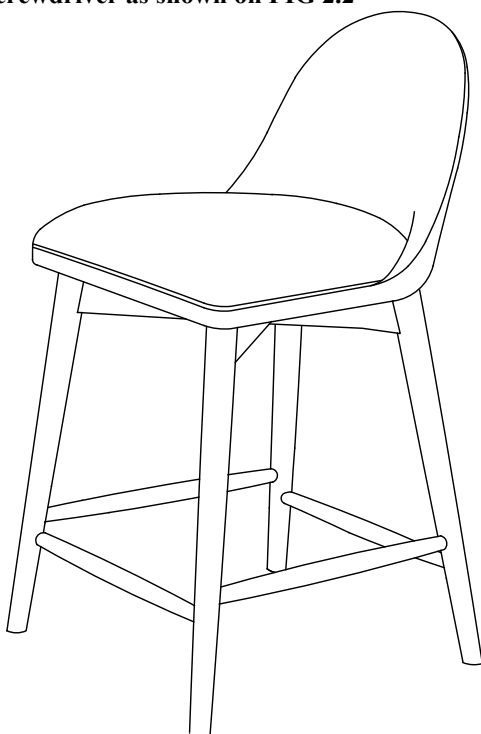

Assembly is now complete.

2 OF 2