

WINNERS ONLY® Assembly Instructions

PROD.NO: DQ14257AET&AEB, DQ14257 ET&EB
DQ14257 WT&WB, DB54257T&B
DPR14257T&B, DP54257T&B

Thank you for purchasing this quality product. Please read the instructions thoroughly before unpacking the assembly parts.









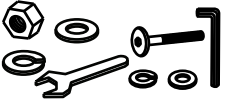

Caution: Sharp exposed staple tips can cause injury, therefore for your protection, please remove any exposed staples used in packing.

Please keep all hardware parts out of the reach of children.



1. We recommend that you should assemble this product with the assistance of another person: this will make the assembly easier, and will help to prevent personal injury and to insure parts are not damaged during the assembly process.
2. Before beginning, please check the packing materials carefully for small parts which may have come loose inside the carton during shipping. Please do not discard any packing material until all parts have been located. If any parts are missing, please contact your dealer for prompt replacement.
3. To prevent damage to your floor or carpet, please check the bottom of each piece of furniture for stain residues and rough surfaces and also check for staples or nails left after removing the packing materials. The manufacturer will not be held responsible if preventive steps are not taken prior to installation.
4. Please do not over tighten screws or bolts. During normal use everyday, screws, bolts, nuts and wooden plugs may loosen up. They should be periodically inspected and re-tightened to prevent damage to the furniture and (or) personal property of cause injury. Always check to be sure all hardware on this list and the below mentioned components are attached to the furniture properly and kept tightened.
5. Please lay all parts and hardware on a non abrasive surface such as a carpet, and follow the assembly.

COMPONENT LIST: DQ14257AET/ET/WT, DB54257T,
DPR14257T, DP54257T





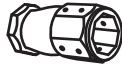



This product will take 15-20 minutes to assemble.

NO	DESCRIPTION	SKETCH	QTY
A	Hardware Bag		1 pack
B	Table Top		1 pce
C	Apron Hinge		4 pcs
D	Leaf Hinge		2 pcs
E	Table Lock		4 pcs
F	Mounting Plate		1 pce
G	Side Panel		2 pcs
H	Apron Leaf		2 pcs
I	Support Leaf Hinge		2 pcs
J	Metal Cable Glides		2 pcs

COMPONENT LIST: DQ14257AEB/EB/WB, DB54257B,
DPR14257B, DP54257B

NO	DESCRIPTION	SKETCH	QTY
K	Pedestal Stand		1 pce
L	Pedestal Leg		4 pcs
M	Adjustable Leveler		4 pcs

HARDWARE LIST:

NO	DESCRIPTION	SIZE	SKETCH	QTY
1	Hex Nut	5/6" x 12.5 x 6.5mm		12pcs
2	Lock Washer (Large)	5/6"(M8) x 13.5 x 1.8mm		12pcs
3	Flat Washer (Large)	5/6" x 22 x 1.2mm		12pcs
4	Wrench	12.8mm		1 pc
5	JCBC Bolt	M6 x 50mm		8 pcs
6	Lock Washer (Small)	M6 x 13 x 2mm		8 pcs
7	Flat Washer (Small)	M6.5 x 16.5 x 1.2mm		8 pcs
8	Allen Key	M4 x 2.1/2"		1 pc

Screw driver is require for assembly (not included)

TIP: store the Allen key and or Wrench used in assembly in this product's drawer or use masking or painter's tape to affix it to the underside of the product. this will make it easier to find if you want to periodically tighten bolts or disassemble the product.

WINNERS ONLY Assembly Instructions

DQ14257AET&AEB / DQ14257 ET&EB / DQ14257 WT&WB / DB54257T&B / DPR14257T&B / DP54257T&B

DQ14257/DB 54257

DPR14257/DP14257-13

DQ14257/DB 54257

DPR14257/DP14257-08

DQ14257/DB 54257

DPR14257/DP54257-07

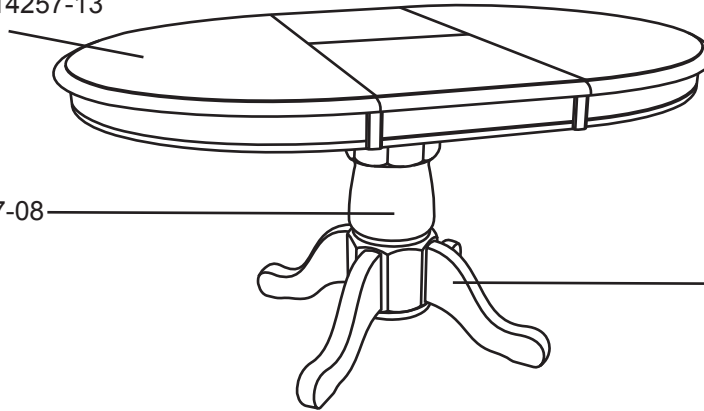

ASSEMBLY :

STEP 1

1.1- Turn the pedestal upside down. Attach legs by inserting hanger bolts through pre-drilled holes on the combination pedestal shown in Fig.1

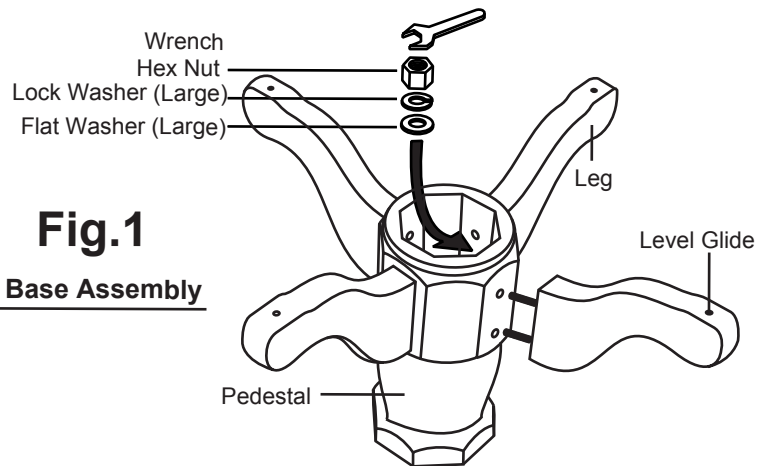

Fig.1

Base Assembly

STEP 2

2.1- Position the table top upside down on a smooth, protective surface such as carpet. Remove all the cleats with Screw Driver (not provided). Install the side panel and mounting plate by using the supply hardware as shown on Fig.2

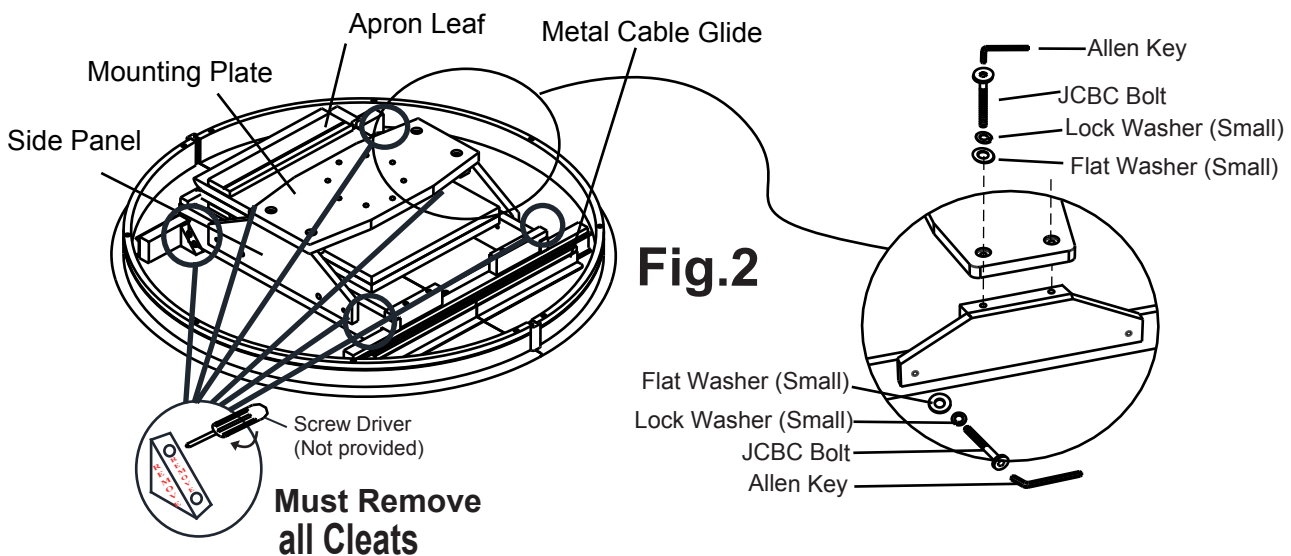

Fig.2

WINNERS ONLY Assembly Instructions

DQ14257AET&AEB / DQ14257 ET&EB / DQ14257 WT&WB / DB54257T&B / DPR14257T&B / DP54257T&B

ASSEMBLY :

STEP 3

3.1- Unlock the metal catches from underneath the table Top and pull the table from both ends. Attached base assembly to the table top mounting plate using the supply hardware as shown on Fig.3

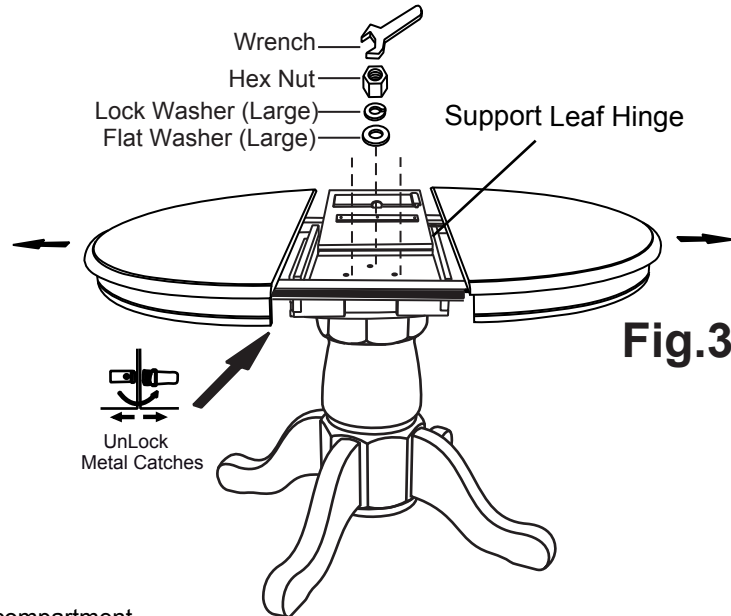

STEP 4

4.1-Lift both leaves from the compartment.

4.2-Flip up the aprons and unfold leaf and place the leaf on the Table Top surface carefully.

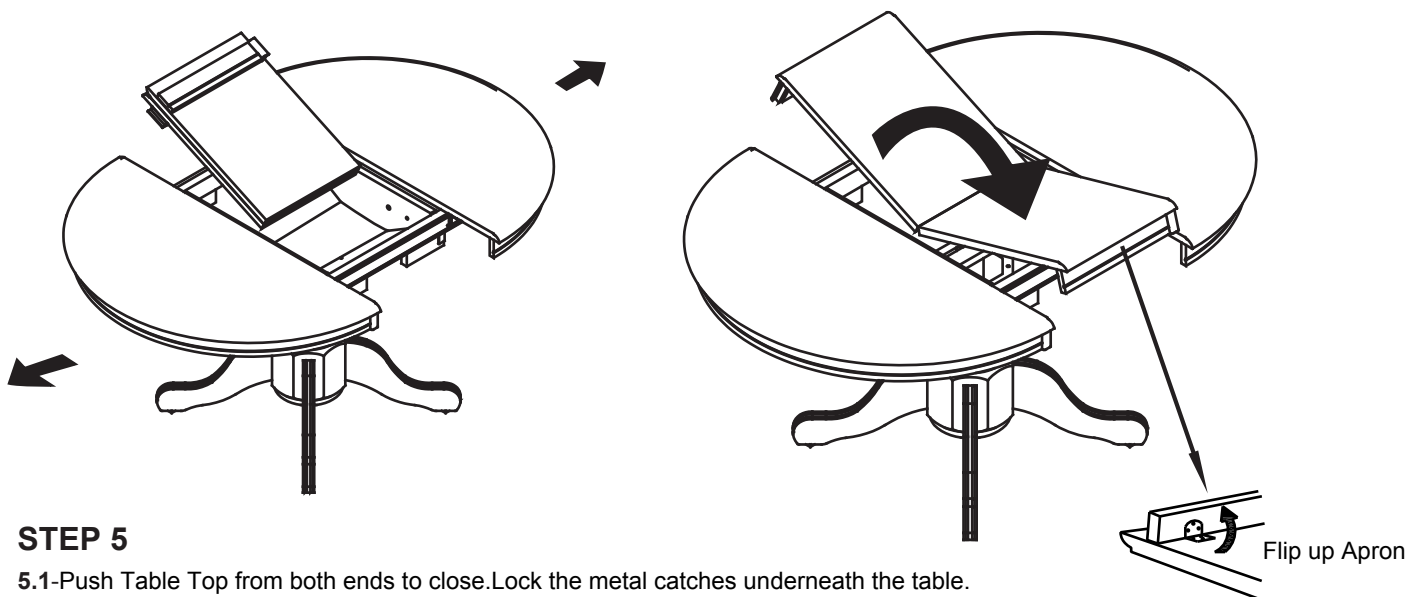

STEP 5

5.1-Push Table Top from both ends to close.Lock the metal catches underneath the table.

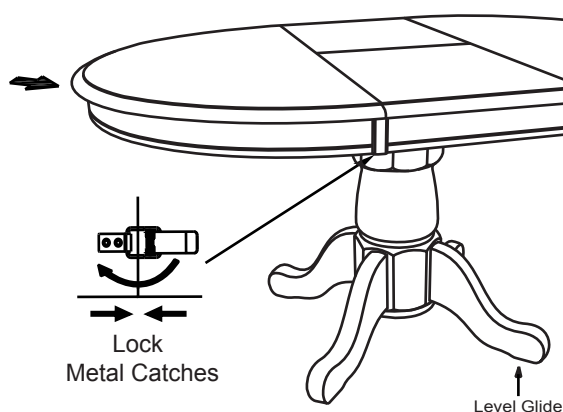

CARE INSTRUCTION

~ Be sure to use the same type of polish consistently.
Your furniture will appear cloudy or streaky if oil based or wax based polishes are interchanged.
~ Spray your furniture surface evenly. Wipe in a circular motion with a soft clean cloth.