

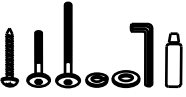

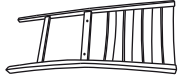

WINNERS ONLY® Assembly Instructions





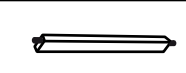

DCT35024G / DCT35024R

Thank you for purchasing this quality product. Be sure to check all packaging material carefully for small parts that may have come loose inside the carton during shipment.

COMPONENT LIST:

PART NO	FIGURE	DESCRIPTION	QTY
DCT35024G-01/ DCT35024R-01		Hardware Bag	1 pce
DCT35024G-02/ DCT35024R-02		Chair Back	1 pce
DCT35024G-03/ DCT35024R-03		Wood Seat	1 pce
DCT35024G-05/ DCT35024R-05		Front Leg (Right)	1 pce
DCT35024G-06/ DCT35024R-06		Front Leg (Left)	1 pce
DCT35024G-10/ DCT35024R-10		Front Stretcher	1 pce
DCT35024G-07/ DCT35024R-07		Side Stretcher (L/R)	2 pcs

HARDWARE LIST:

PART NO	FIGURE	DESCRIPTION	QTY
1		Pan Head Screw	6 pcs
2		JCBC Bolt (Short)	2 pcs
3		JCBC Bolt (Long)	8 pcs
4		Lock Washer	10 pcs
5		Flat Washer	10 pcs
6		Allen Key	1 pce
7		Glue	1 pce

This product will take 15-20 minutes to assemble.

Reminders

1. Use only the hardware supplied.
2. Once the product is assembled, level and tighten all the bolts.
3. Do not over-tighten bolts.
4. This item may require periodic tightening

NOTE:

1. Two or two people are needed for assembly
2. Please keep all hardware parts out of the reach of children.

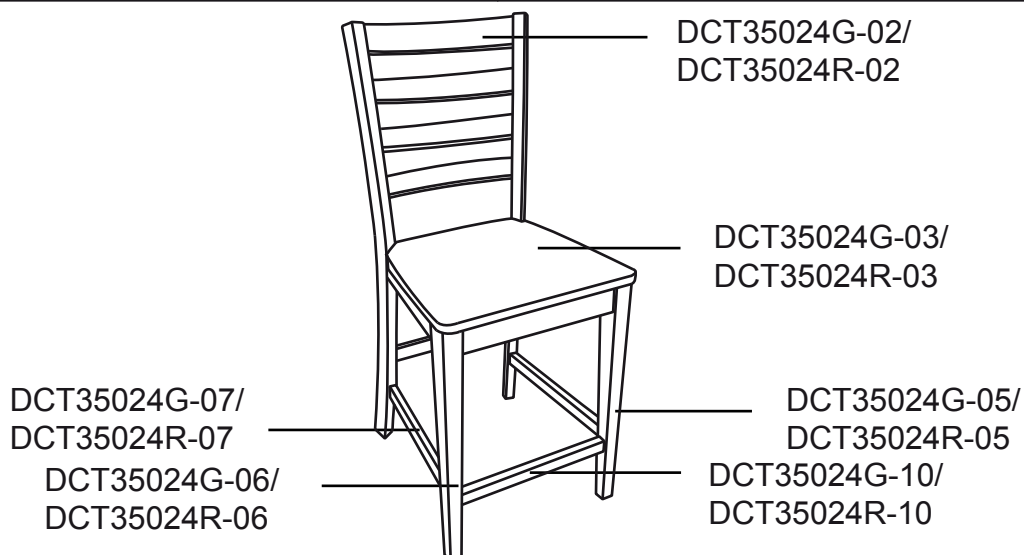

WINNERS ONLY® Assembly Instructions

DCT35024G / DCT35024R

ASSEMBLY :

STEP 1

Step1: Attached wood seat to the chair back using the provided hardware as shown on Fig.1.1 and Fig.1.2.
Step2: Attached front legs (Left and Right) to wood seat and the side and front stretchers to front legs and chair back using the provided hardware as shown in Fig.2.1 and Fig.2.2

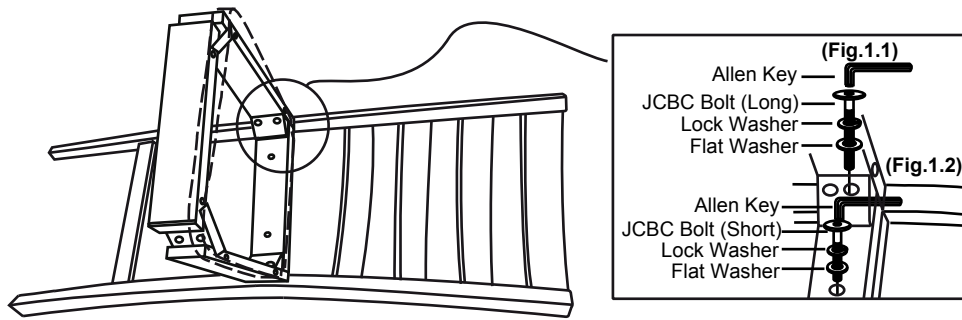

STEP 2

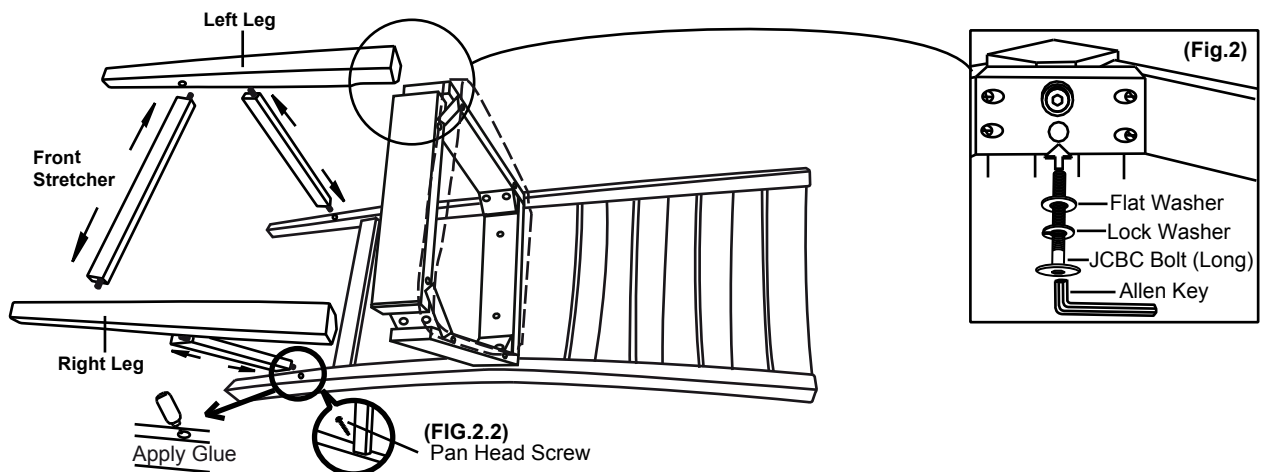

STEP 3

- 3.1- Turn the chair to standing position.
- 3.2- Check it's balance and tighten all screw and bolts to complete the assembly.

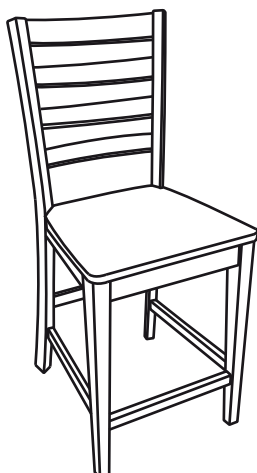

Assembly is now Completed.

CARE INSTRUCTION

- ~ Be sure to use the same type of polish consistently. Your furniture will appear cloudy or streaky if oil based or wax based polishes are interchanged.
- ~ Spray your furniture surface evenly. Wipe in a circular motion with a soft clean cloth.