

WINNERS

ONLY INC.









ASSEMBLY INSTRUCTIONS

PRODUCT NO : DCQ1450S

Thank you for purchasing this quality product. be sure to check all packaging material carefully for small parts that may have come loose inside the carton during shipment.

"Hardware is attached underneath the seat bottom"





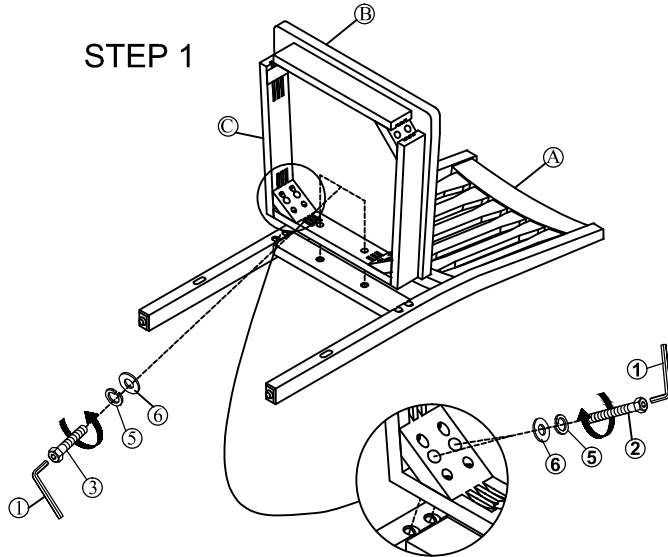

Components List :

NO.	DESCRIPTION	Q' TY
A	 Back Rest	1pc
B	 Wood Seat	1pc
C	 Seat Frame	1pc
D	 Front Leg (Left)	1pc
E	 Front Leg (Right)	1pc
F	 Side stretcher (Left)	1pc
G	 Side stretcher (Right)	1pc
H	 Plastic Glides	4pc

STEP 1



Hardware List :

NO.	DESCRIPTION	SIZE	SKETCH	Q' TY
1	Allen Key	4mm		1pc
2	Allen Bolts	5/16"*3-1/8"		4pcs
3	Allen Bolts	5/16"*1-9/16"		2pcs
4	Allen Bolts	5/16"*2"		4pcs
5	Spring Washer	(8mm)		10pcs
6	Flat Washer	(8*19*2mm)		10pcs
7	Wood Screw	#8*2"		4pcs

STEP 2

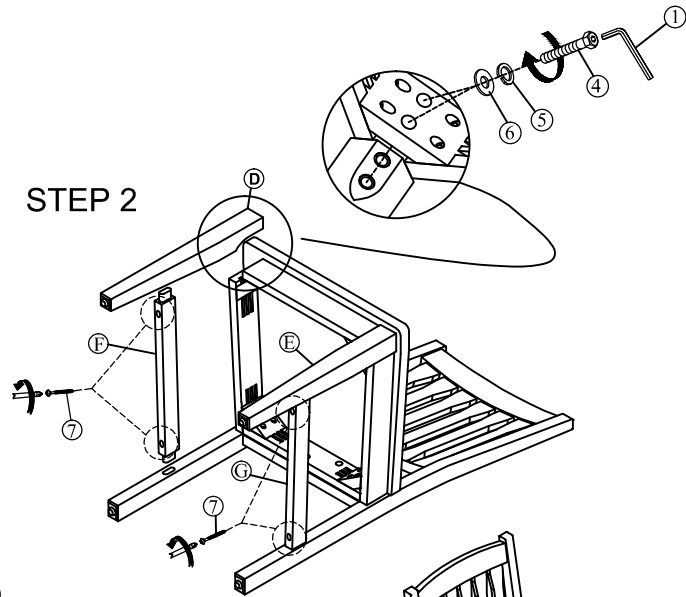

Reminder

1. Use only the hardware supplied
2. Once the chair finished, leveled and tighten all bolts.
3. Do not over-tighten the bolts.
4. This item may require periodic tightening

NOTE:

1. Hardware pack is located underneath the Wood Seat (B).
2. Two or more people are needed for assembly. Please Keep all hardware parts out of the reach of children.

Step 1.1: Attach the Chair Seat (B&C) to Back Rest (A) by using Flat Washer (6). Spring Washer (5) and Bolt (2&3) secure with Allen Key (1)

Step 2: Attach Side Stretcher (F&G) to Back Rest (A) using Wood Screws through pre-drilled holes of Side Stretcher (F&G). Attach the Front Legs (D&E) to the Seat Frame (C) using Flat Washer (6). Spring Washer (5). Bolt (4) tighten with Allen Key (1). Attach Front Legs (D&E) to the Side Stretcher (F&G) using Wood Screws (7) through pre-drilled holes on the Side Stretcher (F&G).

Assembly is now complete

Thank you for purchasing this product.

