



# WINNERS ONLY<sup>®</sup>

## ASSEMBLY INSTRUCTIONS





PROD.NO : BTB/BTG/BTH/BTP1009, BJ3009

Thank you for purchasing this quality product. be sure to check all packaging material carefully for small parts that may have come loose inside the carton during shipment.

### Components List :

NO.	DESCRIPTION	Q' TY
A	 Dresser	1pc
B	 Mirror	1pc
C	 Support Bar	2pcs

### Hardware list

NO.	SKETCH	DESCRIPTION	SIZE	Q'TY
1		Allen Bolt	1/4"*1-5/8"	8pcs
2		Lock Washer	8mm	8pcs
3		Flat Washer	8*19*2mm	8pcs
4		Allen Key	4*30*80mm	1pc

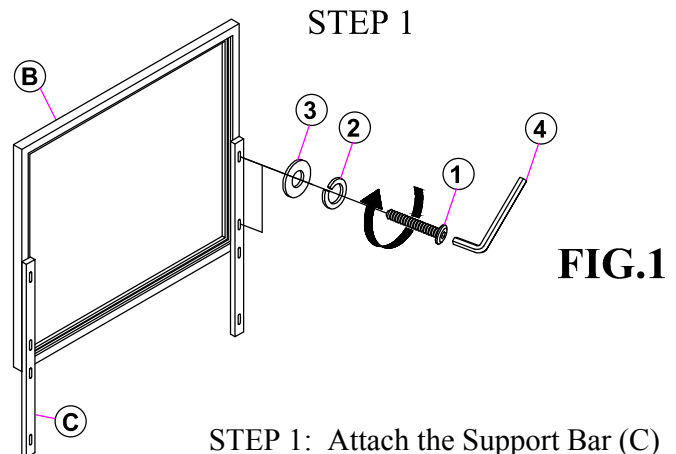

STEP 1: Attach the Support Bar (C) to the Mirror (B) using the provided hardware as shown on FIG.1

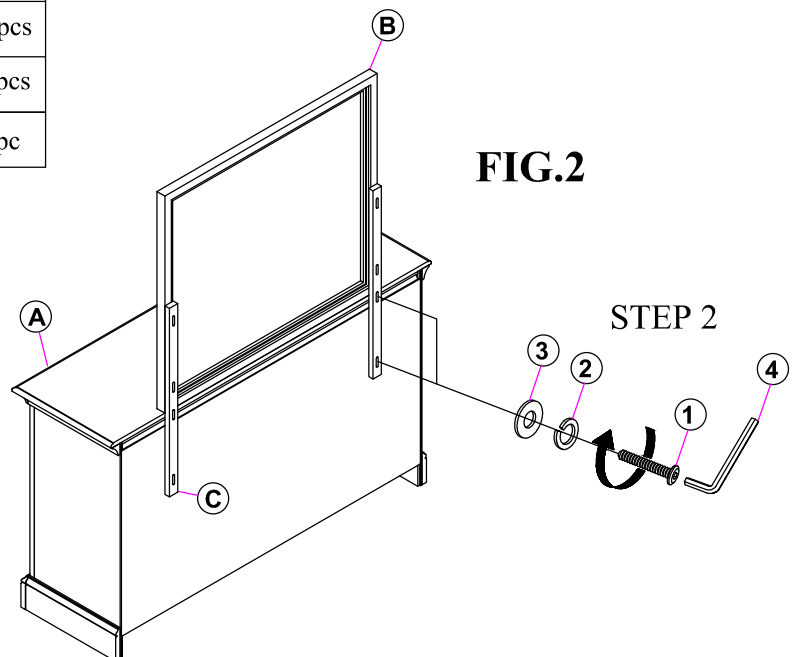

STEP 2: Attach the Mirror assembly (B&C) to Dresser (A) using the provided hardware as shown on FIG.2

Assembly is now completed.

