

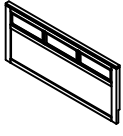

WINNERS ONLY®

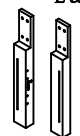



ASSEMBLY INSTRUCTIONS

PROD NO: BH5001KHS/BH5001CKHS

Component List :

(A) Headboard Panel  1pc	(B) Headboard Legs L & R  2pcs	(C) Headboard stretcher  1pc
---	---	--

Hardware List :

(1) Bolt $\phi 5/16"$ x L44mm  10pcs	(2) Spring Washer $5/16"$ ($\phi 12$)*2mm  10pcs	(3) Flat Washer $5/16"$ ($\phi 19$)*2mm  10pcs	(4) Allen Key $4*59$ mm  1pc
---	---	---	---

Caution: Please read instructions thoroughly before unpacking assembly parts. Sharp, exposed staple tips can cause injury, therefore, for your protection, please remove any exposed staples used in packing.

Please keep all hardware parts out of the reach of children.

1. We recommend that you should assemble this product with the assistance of another person; this will make assembly easier, and will help to eliminate damage to the product or injury to person during assembly.
2. Be sure to check all packing materials carefully for small parts that may have come loose inside the carton during shipment.
3. Please do not over tighten screws or bolts.
4. Please put all parts on a non-abrasive floor before assembly, and follow the assemble steps to assemble your newly purchased product correctly and efficiently.

Step 1: Lay the Headboard Panel frontside down on a smooth and clean surface.

Step 2: Attach Left and Right Headboard Legs (B) to the Headboard Panel (A) using Bolt (1), Spring Washer (2), Flat Washer (3). Do not fully tighten yet.

Step 3: Attach Headboard Stretcher (C) to Left and Right Headboard Legs (B) using Bolt (1), Spring Washer (2), Flat Washer (3).

Step 4: Fully tighten all bolts with Allen Key (4)

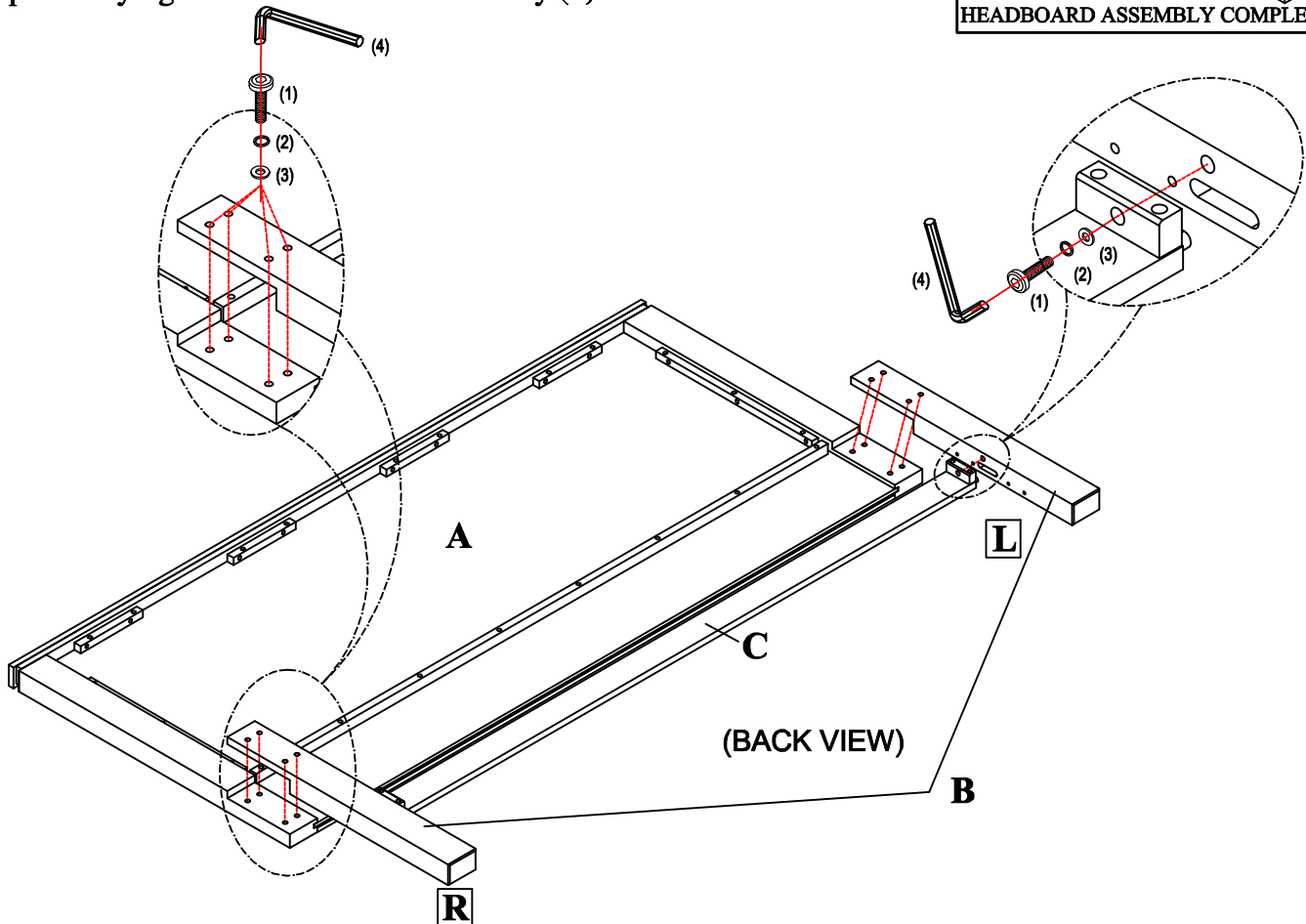
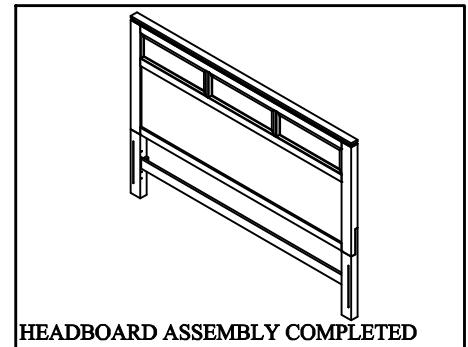





WINNERS ONLY®

ASSEMBLY INSTRUCTIONS

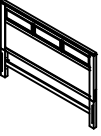
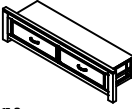
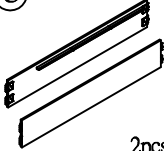
PROD NO: BH5001KHS/BH5001KFS/BH5001KRS

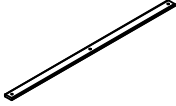
Component List :

<p>(A) Headboard</p>  <p>1pc</p>	<p>(B) Storage Footboard</p>  <p>1pc</p>	<p>(C) Side Rail</p>  <p>2pcs</p>	<p>(D) Slat roll</p>  <p>1 set</p>	<p>(E) Slat Support</p>  <p>2pcs</p>	<p>(F) Slat Support Leg</p>  <p>6pcs</p>
---	--	---	--	---	--

Hardware List :

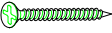
<p>(1) Screw #8*25mm</p>  <p>26pcs</p>

Caution: Please read instructions thoroughly before unpacking assembly parts. Sharp, exposed staple tips can cause injury, therefore, for your protection, please remove any exposed staples used in packing.

Please keep all hardware parts out of the reach of children.

1. We recommend that you should assemble this product with the assistance of another person; this will make assembly easier, and will help to eliminate damage to the product or injury to person during assembly.
2. Be sure to check all packing materials carefully for small parts that may have come loose inside the carton during shipment.
3. Please do not over tighten screws or bolts.
4. Please put all parts on a non-abrasive floor before assembly, and follow the assemble steps to assemble your newly purchased product correctly and efficiently.

