





# WINNERS ONLY®

## ASSEMBLY INSTRUCTIONS

PROD NO: BB2001F , BB2001Q , BB2001K , BB2001CK

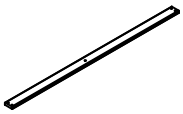
### Component List :

<b>(A) Headboard</b>  1pc	<b>(B) Footboard</b>  1pc	<b>(C) Side Rail</b>  2pcs	<b>(D) Slats</b>  4 pcs	<b>(E) Slat Support Leg</b>  8 pcs
---	--	---	--	---

### Hardware List :

<b>(1) Screw #8*25mm</b>  16 pcs
---

**Caution:** Please read instructions thoroughly before unpacking assembly parts. Sharp, exposed staple tips can cause injury, therefore, for your protection, please remove any exposed staples used in packing.

*Please keep all hardware parts out of the reach of children.*

1. We recommend that you should assemble this product with the assistance of another person; this will make assembly easier, and will help to eliminate damage to the product or injury to persons during assembly.
2. Be sure to check all packing materials carefully for small parts that may have come loose inside the carton during shipment.
3. Please do not over tighten screws or bolts.
4. Please put all parts on a non-abrasive floor before assembly, and follow the assembly steps to assemble your newly purchased product correctly and efficiently.

*NOTE: Bunkie Board must be used to replace Box Spring.*

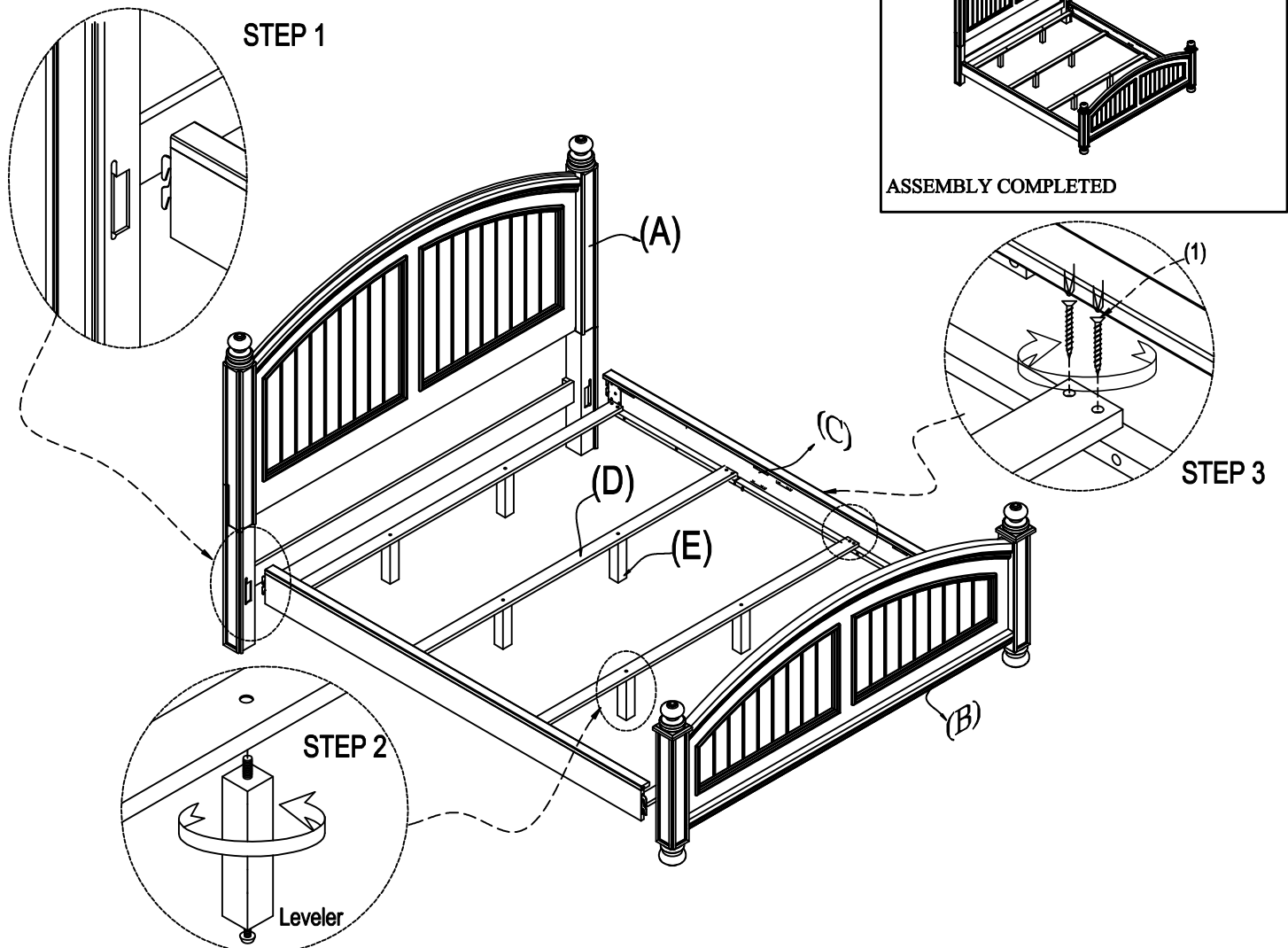

# WINNERS ONLY®



## ASSEMBLY INSTRUCTIONS

PROD NO: BB2001F , BB2001Q , BB2001K , BB2001CK

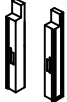
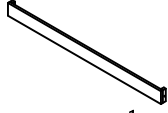
Component List :

<p>(A) Headboard Panel</p>  <p>1pc</p>	<p>(B) Headboard Legs L &amp; R</p>  <p>2pcs</p>	<p>(C) Headboard Stretcher</p>  <p>1pc</p>
--	---	---

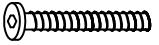
Hardware List :

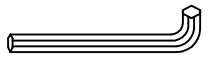
<p>(1) Long JCBC Bolt ø5/16" x L44mm</p>  <p>10pcs</p>	<p>(2) Spring Washer 5/16"(Φ12)*2mm</p>  <p>10pcs</p>	<p>(3) Flat Washer 5/16"(Φ16)*2mm</p>  <p>10pcs</p>	<p>(4) Allen Key 4*59mm</p>  <p>1pc</p>
---	---	--	--

**Caution:** Please read instructions thoroughly before unpacking assembly parts. Sharp, exposed staple tips can cause injury, therefore, for your protection, please remove any exposed staples used in packing.

*Please keep all hardware parts out of the reach of children.*

1. We recommend that you should assemble this product with the assistance of another person; this will make assembly easier, and will help to eliminate damage to the product or injury to persons during assembly.
2. Be sure to check all packing materials carefully for small parts that may have come loose inside the carton during shipment.
3. Please do not over tighten screws or bolts.
4. Please put all parts on a non-abrasive floor before assembly, and follow the assembly steps to assemble your newly purchased product correctly and efficiently.

**Step 1:** Lay the Headboard Panel frontside down on a smooth and clean surface.

**Step 2:** Attach Left and Right Headboard Legs (B) to the Headboard Panel (A) using Long Bolt (1), Spring Washer (2), Flat Washer (3). Do not fully tighten yet.

**Step 3:** Attach Headboard Stretcher (C) to Left and Right Headboard Legs (B) using Long Bolt (1), Spring Washer (2), Flat Washer (3), tighten with Allen Key (4).

**Step 4:** Fully tighten all the bolts.

