





ASSEMBLY INSTRUCTIONS

ITEM #: P012180 / P012183 / P012172





DESCRIPTION: KING BLANKET CHEST BED





Thank you for purchasing this quality product. Be sure to check all packing material carefully for small parts that may have come loose inside the carton during shipment. Identify and count all hardware and compare with the hardware list below.

TOOLS REQUIRED (NOT PROVIDED)	
Phillips screwdriver	

HARDWARE LIST HEADBOARD:				
No.	Description	Sketch	Size	Q'ty
A	Allen bolt		Ø1/4" x 2.3/8"	10 Pcs
B	Lock washer		Ø1/4"	10 Pcs
C	Flat washer		Ø1/4" x 3/4"	10 Pcs
D	L Allen key		M4	1 Pc

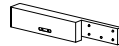
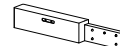
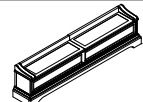
HARDWARE LIST FOOTBOARD:				
No.	Description	Sketch	Size	Q'ty
E	Screw		M4 x 1.1/4"	10 Pcs

HARDWARE LIST RAIL:				
No.	Description	Sketch	Size	Q'ty
F	Hanger bolt		Ø5/16" x 3.1/2"	8 Pcs
G	Hexagon nut		Ø5/16"	8 Pcs
H	Lock washer		Ø5/16"	8 Pcs
I	Wrench		12mm	1 Pc

PARTS LIST:			
No.	Description	Sketch	Q'ty
1	Headboard		1 Pc
2	Headboard Leg-Right		1 Pc
3	Headboard Leg-Left		1 Pc
4	Footboard		1 Pc
5	Slat		5 Pcs
6	Support Leg		10 Pcs
7	Side Rail		2 Pcs

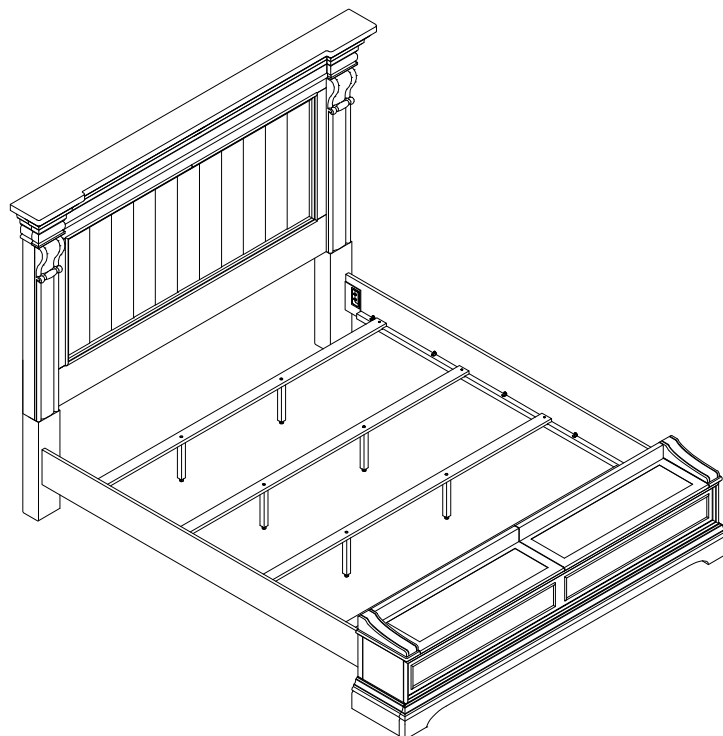

RESIDENTIAL USE ONLY

MADE IN VIET NAM

ASSEMBLY INSTRUCTIONS

ITEM #: P012180 / P012183 / P012172

DESCRIPTION: KING BLANKET CHEST BED

Thank you for purchasing this quality product. Be sure to check all packing material carefully for small parts that may have come loose inside the carton during shipment. Identify and count all hardware and compare with the hardware list below.

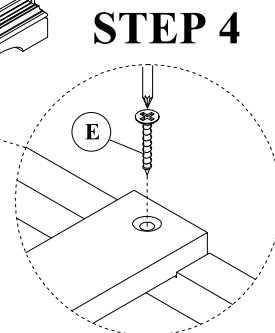
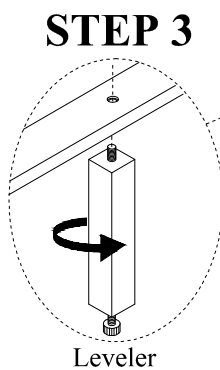
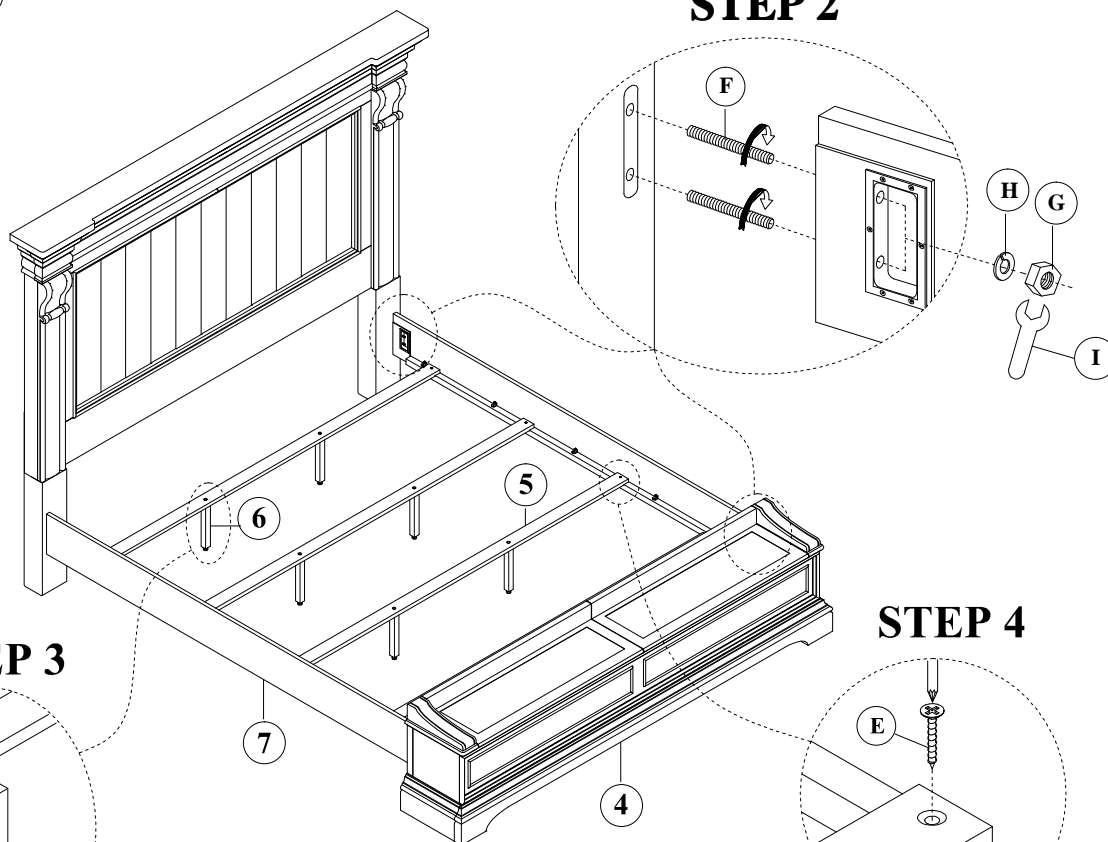
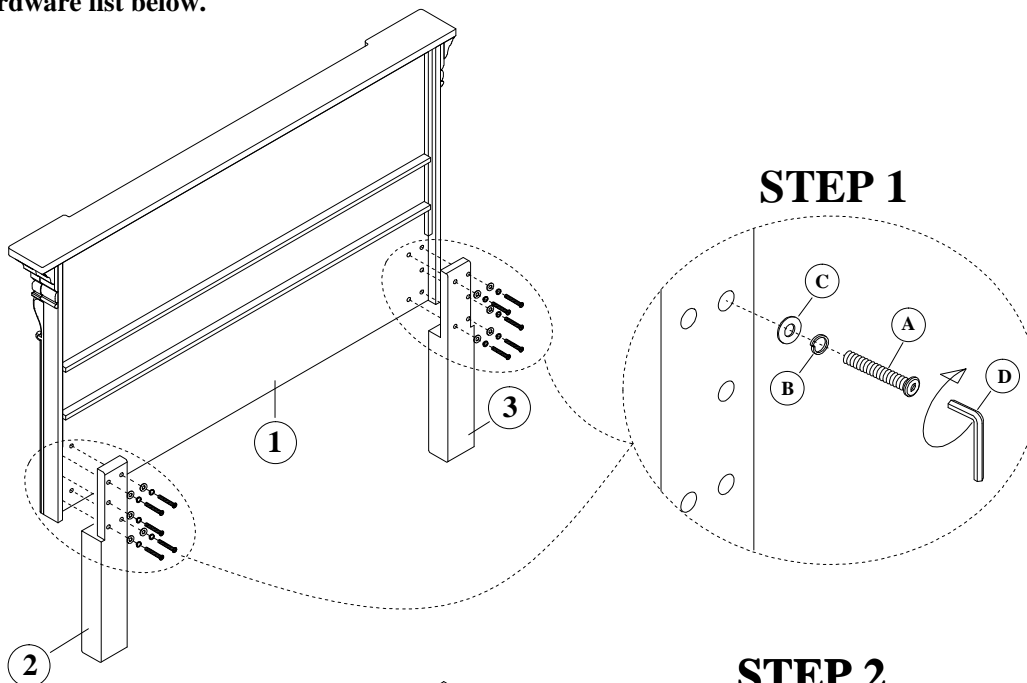

RESIDENTIAL USE ONLY

MADE IN VIET NAM