







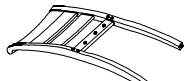

ITEM#: 652-C2000S

DESCRIPTION : LADDER BACK BACK SIDE CHAIR
(RTA)

Thank you for purchasing this quality product. Be sure to check all packing material carefully for small Hardware which may have come loose inside the carton during shipment. Identify and count all Hardware and compare with the Hardware List Below.

PARTS LIST			
①	Chair Seat Frame		1 Pc
②	Front Leg		2 Pcs
③	Chair Back		1 Pc

HARDWARE LIST			
Ⓐ	JCBC Screw Ø1/4" x 50mm		4 Pcs
Ⓑ	JCBC Screw Ø1/4" x 38mm		2 Pcs
Ⓒ	JCBC Screw Ø1/4" x 70mm		4 Pcs
Ⓓ	Spring Washer Ø1/4"		10 Pcs
Ⓔ	Flat Washer Ø1/4" x 19mm x 2mm		10 Pcs
Ⓕ	Allen Key		1 Pc

NOTE: Do not fully tighten Bolts until the assembly is completed.

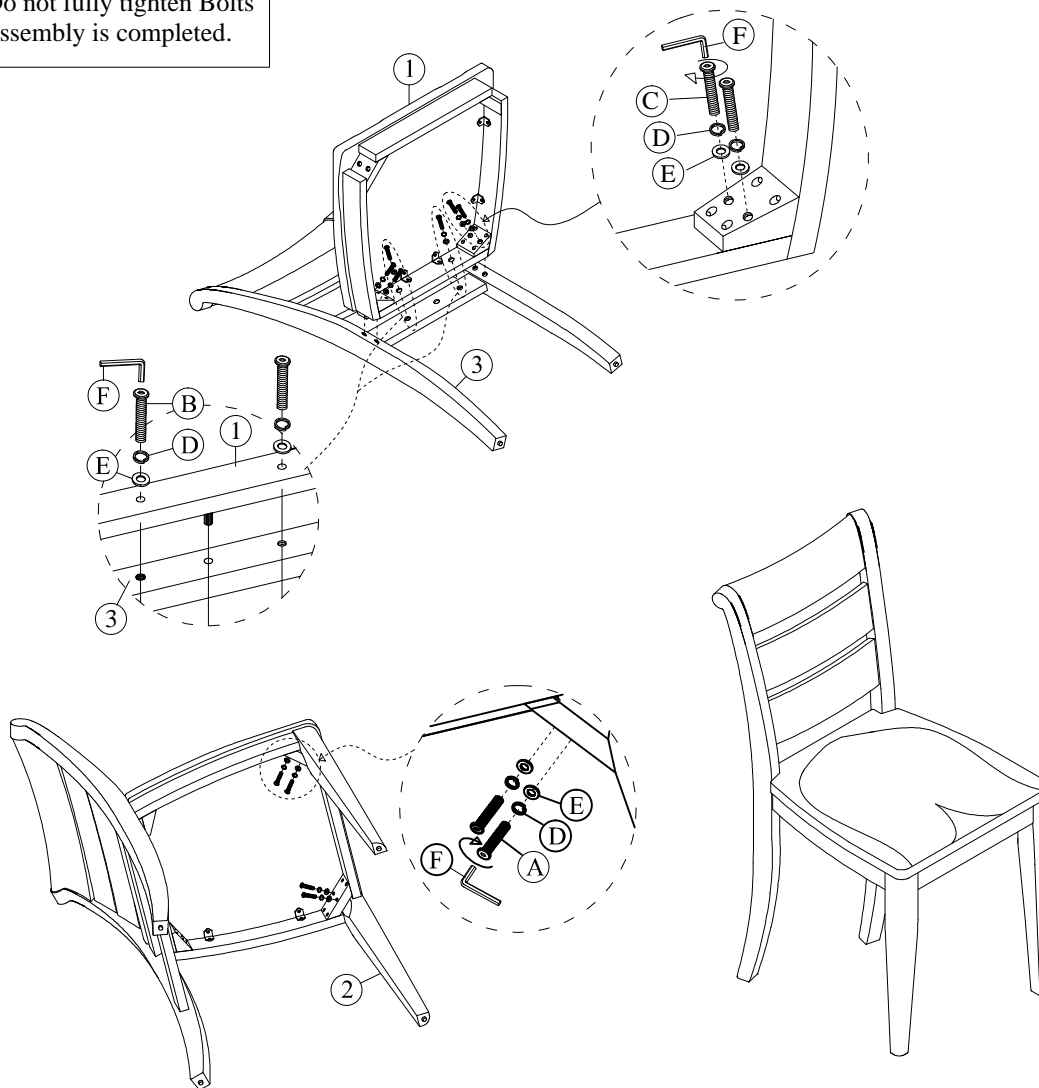

Chair Assembly Tips

Having some trouble putting together your new furniture? we can help! The key to correct chair assembly is to loosely attach all of the bolts, then gradually tighten them in succession until all of them are secure. Completely tightening one or more bolts prematurely can result in the following:

ISSUE: CHAIR IS UNLEVELED

Cause:

. Chairs can be wobbly or unlevelled if one or more bolts are fully tightened before all bolts are attached and/or tightened.

Solution:

. Loosen each bolt in the seat box (front legs, back corner- blocks, and back apron) until they're finger tight. Place the chair upright on the floor. Press firmly and evenly on the seat edges until the product sits level but do not lean against the chair back. Once the chair sits level on the desired surface, fully tighten each bolt.

Cause:

.Chair can be wobbly or unlevelled if assembly is completed in a different room or surface than where the product is intended to primarily reside.

Solution:

When assembling your chair, make sure to do it in the location that the chair will most often be used. Uneven flooring frequently accounts for wobbling issues.

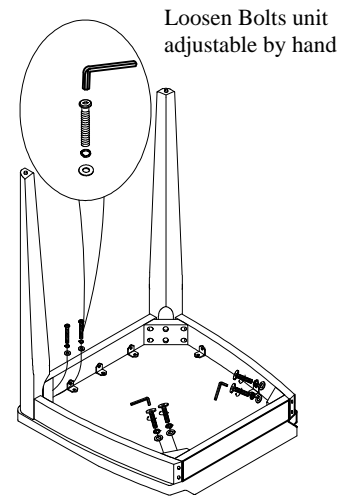

ISSUE: HOLES ARE MISALIGNED

Cause:

.This issue can occur when some bolts are tightened fully before all other bolts are tightened or attached.

Solution:

.Loosen each bolt in the seat box (front legs, back corner-blocks, and back apron) until finger tight. This will allow you to realign the holes and properly fasten the bolts to the frame.