



## ASSEMBLY INSTRUCTION

ITEM: (US17007M) SS736-RPH1-012 Vann RAF PWR Recliner  
w/PWR Headrest

Thank you for purchasing this quality product. Be sure to unpack carefully looking for small parts which may have come loose during shipment.

Read all instruction and study the drawing carefully before starting the assembly process.

### PART LIST

NO .	DESCRIPTION	SKETCH	QTY
A	Seat		1PC
B	Back Cushion		1PC
C	Power cord		1PC

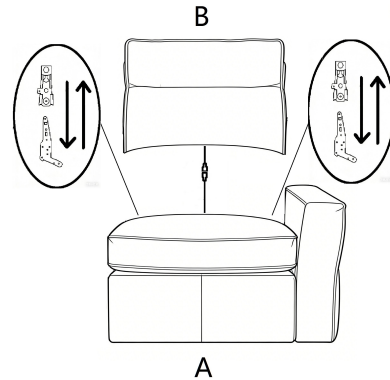
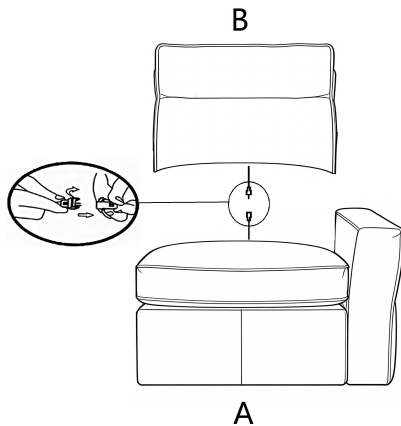
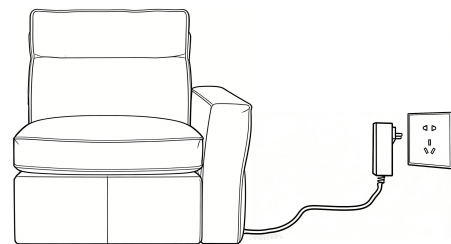
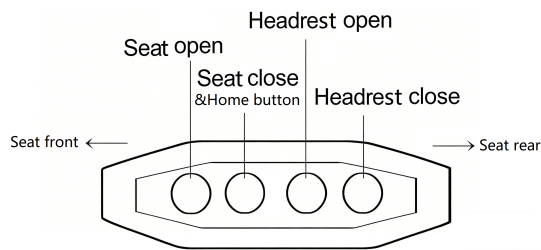

STEP 1 - Connect the wire on back cushion and seat cushion

STEP 2 - Place Bracket into Sleeve and press top of back down firmly to lock your KD back in place

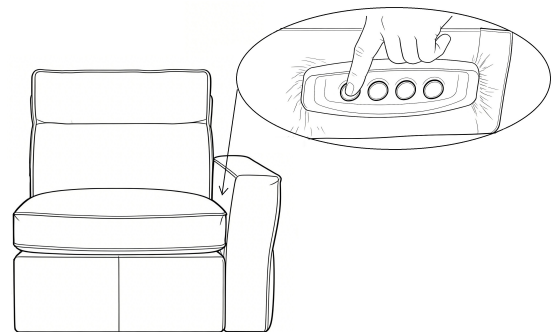
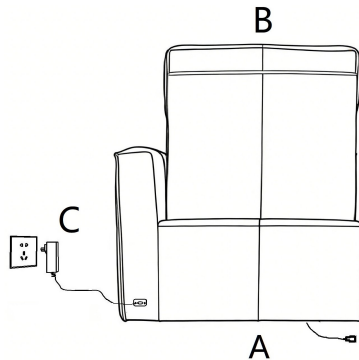

STEP 3 - Connect the connector from motor to the power cord and transformer

STEP 4 - Locate the hand controller on the side of seat cushion to enjoy your Hooker Furnishing

### CAUTION

Do not allow children to play on this mechanism furniture or operate the mechanism. Leg rest folds down on closing so that child could possibly be injured. Always leave in an upright and closed position and keep hands feet clear of mechanism. Only the occupant should operate it.

# HOOKER<sup>®</sup> FURNISHINGS ASSEMBLY INSTRUCTION

ITEM: (US17007M) SS736-A-012 Vann Armless Chair  
(US17007M) SS736-APPH-012 Vann Armless Recliner w/PWR Headrest  
(US17007M) SS736-C-012 Vann Corner Wedge  
(US17007M) SS736-CS-012 Vann Console w/Hidden Cupholders  
(US17007M) SS736-LPH1-012 Vann LAF PWR Recliner w/PWR Headrest  
(US17007M) SS736-RPH1-012 Vann RAF PWR Recliner w/PWR Headrest

**CAUTION:** Read the important instructions below before operating your power mechanized equipment.  
Do not allow children to play on or operate this power mechanized equipment

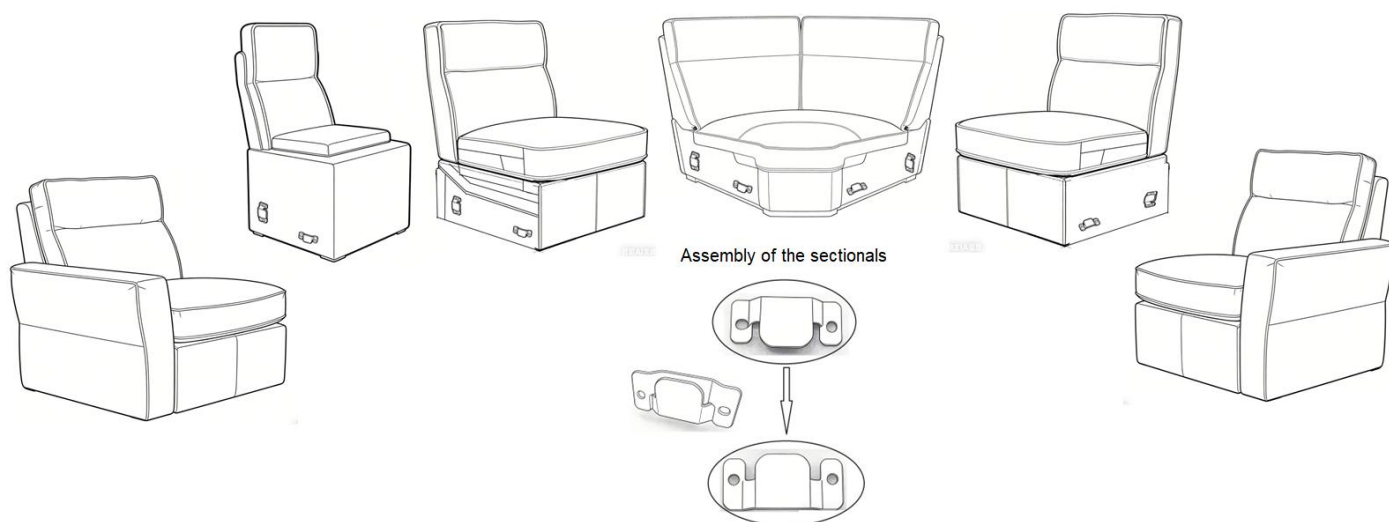

Gently lift up the unit with bracket facing down slightly and lower it onto the up facing bracket locking the sections together.

Do Not plug the power cord into power outlet until your recliner is fully assembled and in place.

**NOTES:**

- 1) To help prevent shock and or damage to your product only plug the power cord into a grounded outlet.
- 2) Read the operating instructions carefully before operating your power sofa.