

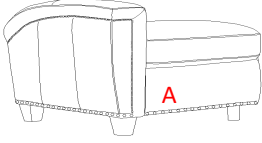

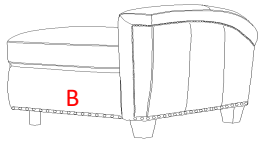
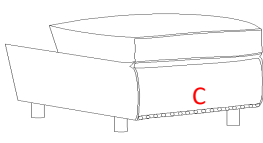
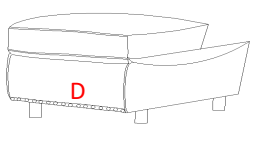
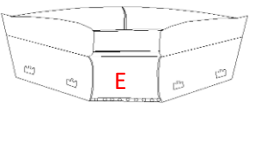
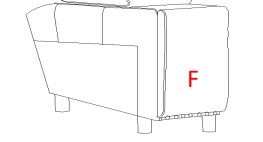

# ASSEMBLY INSTRUCTION

ITEM: SS831-LPHZ1-088 Julian ZG LAF PWR Recliner w/PWR Headrest  
 SS831-RPHZ1-088 Julian ZG RAF PWR Recliner w/PWR Headrest  
 SS831-APPH-088 Julian ZG Armless PWR Recliner w/PWR Headrest  
 SS831-CS-088 Julian Console w/Hidden Cupholders  
 SS831-C-088 Julian Corner Wedge  
 SS831-A-088 Julian Armless Chair

Thank you for purchasing this quality product. Be sure to unpack carefully looking for small parts which may have come loose during Read all instruction and study the drawing carefully before starting the assembly process.

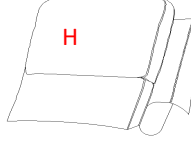
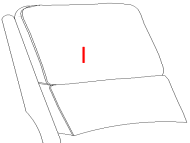
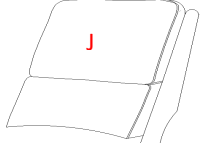
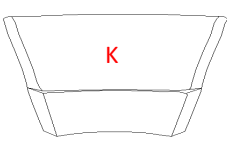
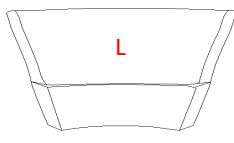
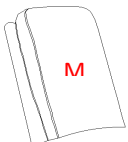
**CAUTION:** Make sure to read the instructions below assembling your four motor lift chair. We suggest two people be used in the assembly of your lift chair.

			
Laf Pwr Recliner Base : 1 PC	Raf Pwr Recliner Base : 1 PC	Armless Base : 1 PC	Armless Pwr Recliner Base : 1 PC
			
Corner Wedge Base : 1 PC	Console Base : 1 PC	Laf Pwr Recliner Back : 1 PC	Raf Pwr Recliner Back : 1 PC
			
Armless Back : 1 PC	Armless Pwr Recliner Back : 1 PC	Laf Corner Wedge Back : 1 PC	Raf Corner Wedge Back : 1 PC
			
Console Back : 1 PC	Corner Wedge Legs : 5 Pcs	Power Source : 1PC	

**Step 1:** Remove plastic glides from bottom of legs to access assembly bolts. On legs use the large plastic washer then assemble the legs in each corner by alien head wrench provided. Please make all bolts are installed correctly before putting glides on.

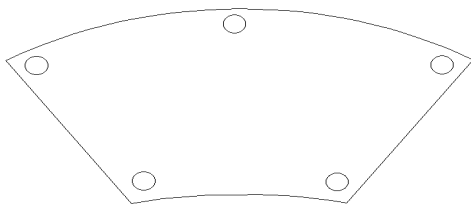

**Step 2:** Ensure both clips on back are aligned, then press top of back frame downward until a clicking sound is heard

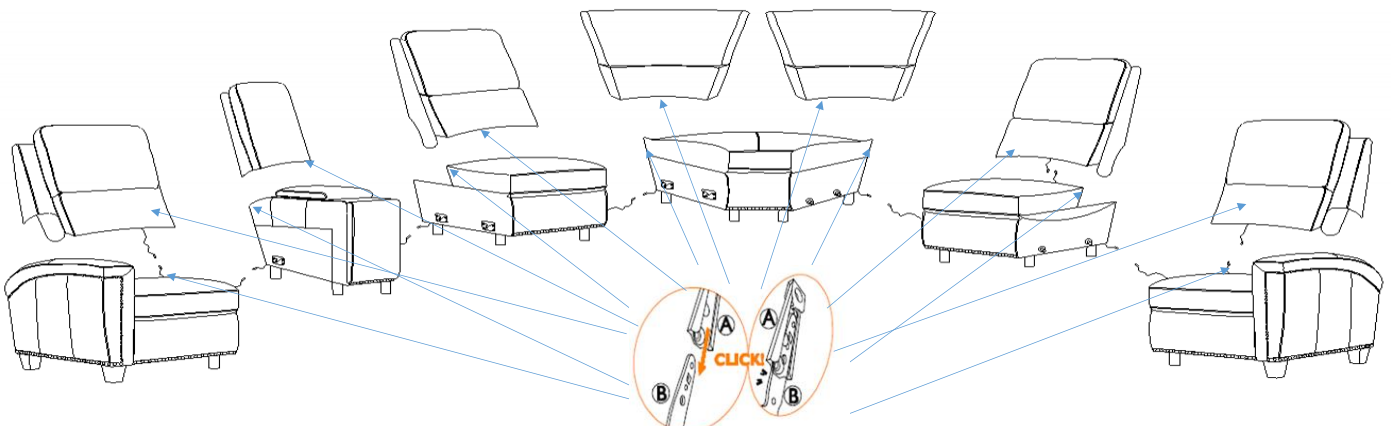

# ASSEMBLY INSTRUCTION

ITEM: SS831-LPHZ1-088 Julian ZG LAF PWR Recliner w/PWR Headrest  
SS831-RPHZ1-088 Julian ZG RAF PWR Recliner w/PWR Headrest  
SS831-APPH-088 Julian ZG Armless PWR Recliner w/PWR Headrest  
SS831-CS-088 Julian Console w/Hidden Cupholders  
SS831-C-088 Julian Corner Wedge  
SS831-A-088 Julian Armless Chair

Thank you for purchasing this quality product. Be sure to unpack carefully looking for small parts which may have come loose during shipment. Read all instruction and study the drawing carefully before starting the assembly process.

**CAUTION:** Make sure to read the instructions below assembling your four motor lift chair. We suggest two people be used in the assembly of your lift chair.

**Step 3:** Assembly of the sectionals. The prong and connector must be aligned well.

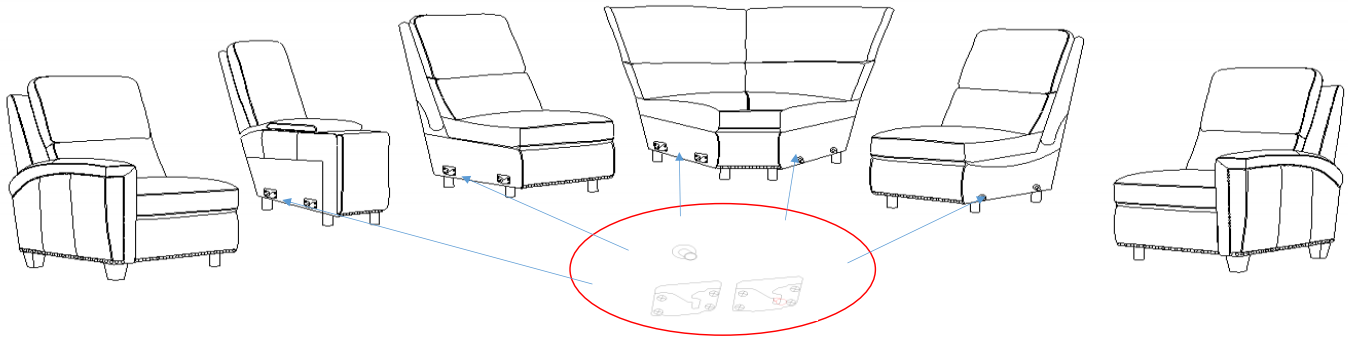

**Step 4:** Connect the power cord for the backrest and seat, and then connect all the bottom connectors of the sofas together as shown below.

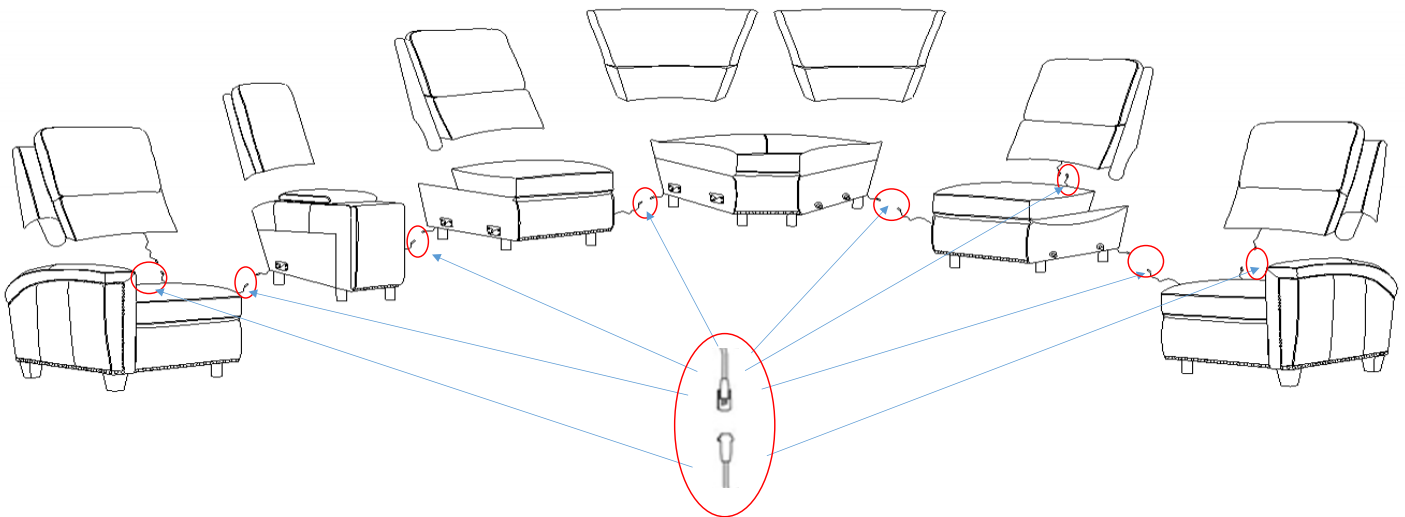

### CAUTION

Do not allow children to play on this mechanism furniture or operate the mechanism. Leg rest folds down on closing so that child could possibly be injured. Always leave in an upright and closed position and keep hands feet clear of mechanism. Only the occupant should operate it.

# ASSEMBLY INSTRUCTION

ITEM: SS831-LPHZ1-088 Julian ZG LAF PWR Recliner w/PWR Headrest  
SS831-RPHZ1-088 Julian ZG RAF PWR Recliner w/PWR Headrest  
SS831-APPH-088 Julian ZG Armless PWR Recliner w/PWR Headrest  
SS831-CS-088 Julian Console w/Hidden Cupholders  
SS831-C-088 Julian Corner Wedge  
SS831-A-088 Julian Armless Chair

Thank you for purchasing this quality product. Be sure to unpack carefully looking for small parts which may have come loose during shipment. Read all instruction and study the drawing carefully before starting the assembly process.

**CAUTION:** Make sure to read the instructions below assembling your four motor lift chair. We suggest two people be used in the assembly of your lift chair.

**Step 5: Connect headrest power cord as shown below.**

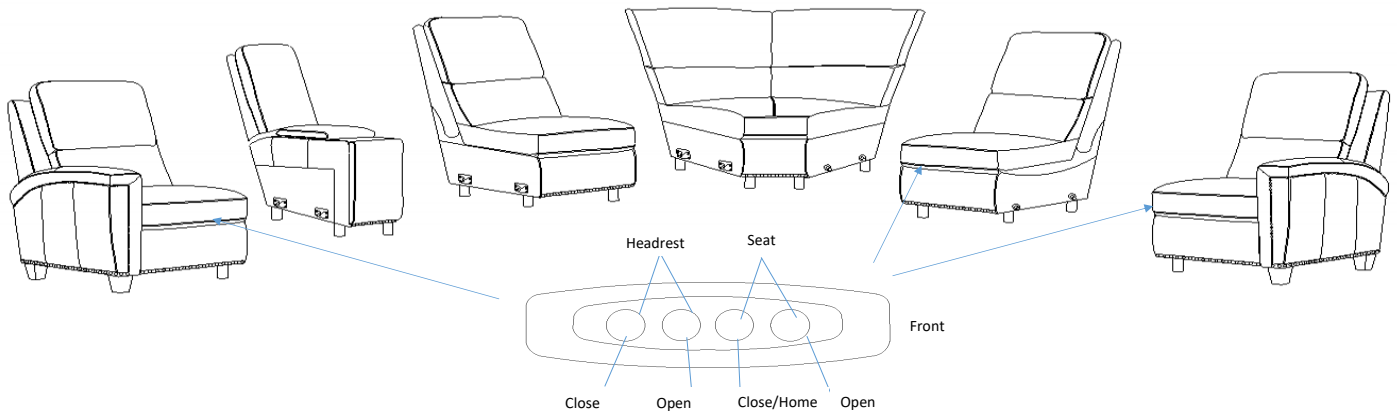

**Step 6:** Attached the outside back along the bottom rear of the base frame with the pre attached velcro, Connect the connector from motor to the power cord and transformer. Then it's ready to use.

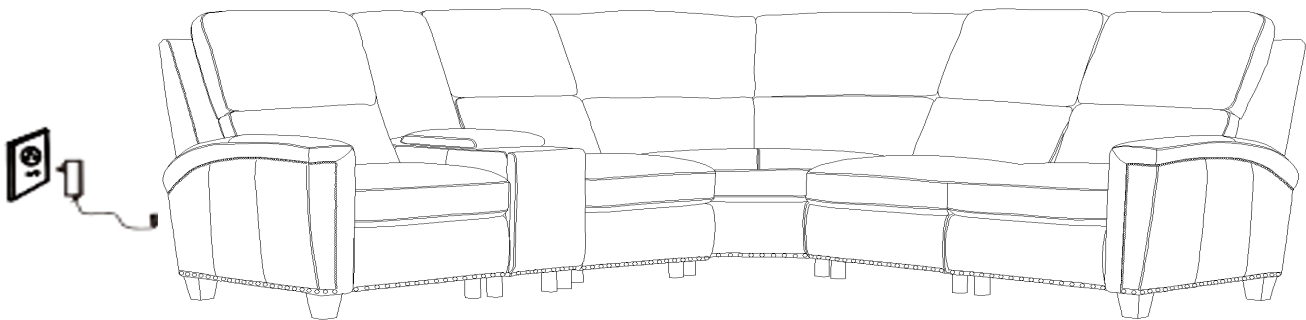

### CAUTION

Do not allow children to play on this mechanism furniture or operate the mechanism. Leg rest folds down on closing so that child could possibly be injured. Always leave in an upright and closed position and keep hands feet clear of mechanism. Only the occupant should operate it.