





ASSEMBLY INSTRUCTION

Item: 6133-75906-80 Display Cabinet



Thank you for purchasing this quality product. Be sure to unpack carefully looking for small parts which may have come loose during shipment.

Read all instruction and study the drawing carefully before starting the assembly process.

HARDWARE PACK

NO.	DRAWING	DESCRIPTION	SIZE	QTY
A		Bolt	1/4"x3/4"	2pcs
B		Flat washer	1/4"x16x2	2pcs
C		Lock washer	1/4"x12x3	2pcs
D		Allen key	4mm	1pc

PART LIST

NO.	DRAWING	DESCRIPTION	QTY
①		Cabinet	1pc
②		Adjustable Shelf	2pcs
③		Glass	3pcs

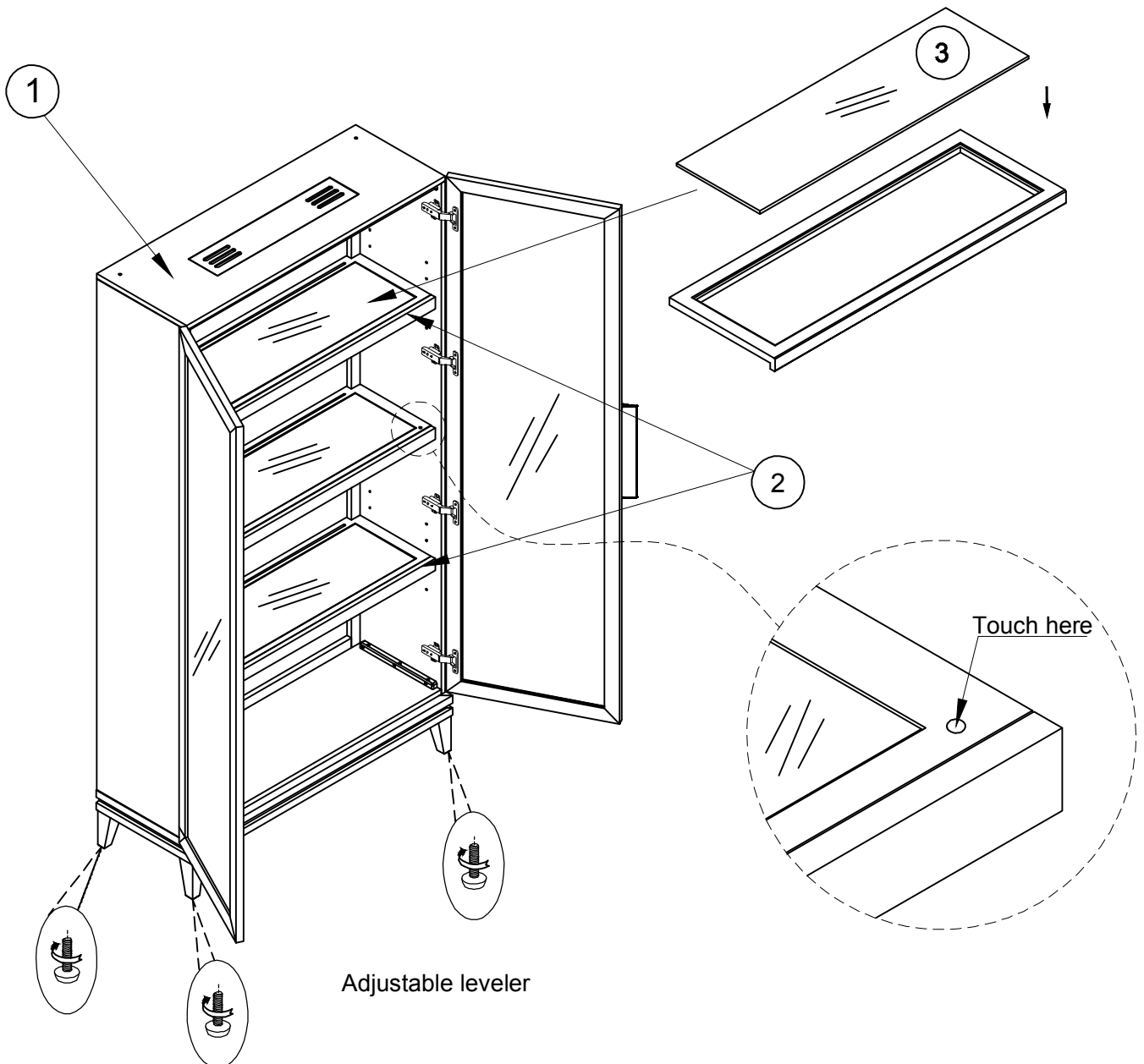

Adjustable leveler