







Thank you for purchasing this quality product. Be sure to unpack carefully looking for small parts which may have come loose during shipment.

Read all instruction and study the drawing carefully before starting the assembly process.

**HARDWARE PACK**

NO.	DRAWING	DESCRIPTION	SIZE	Q'TY
A		Bolt	Ø1/4 * 2-15/16"	8pcs
B		Lock Washer	Ø1/4"*10mm	8pcs
C		Flat Washer	Ø1/4"*19mm	8pcs
D		Allen Wrench	4mm	1pc

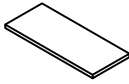
**PART LIST**

NO.	DRAWING	DESCRIPTION	Q'TY
①		Table top	1pc
②		Leg	2pcs
③		Bottom stretcher	1pc

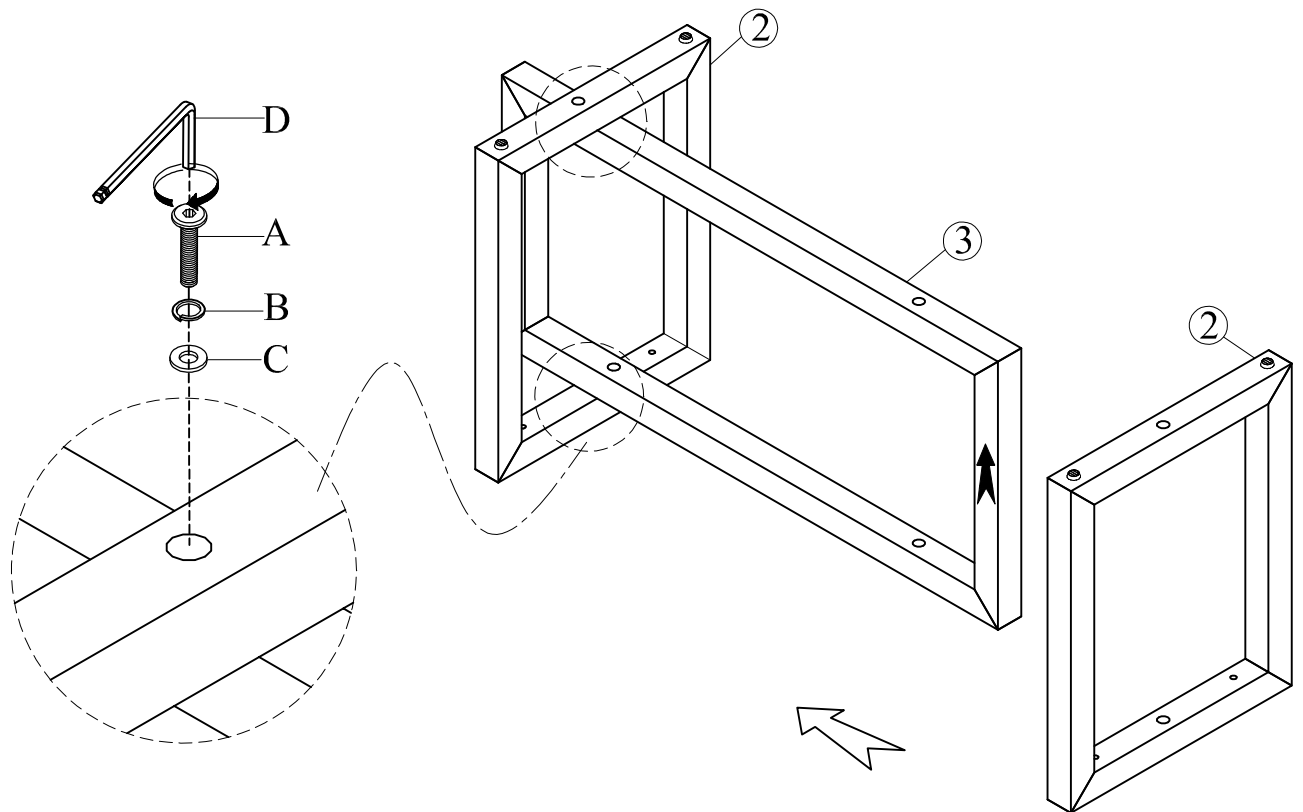

**STEP 1**

Thank you for purchasing this quality product. Be sure to unpack carefully looking for small parts which may have come loose during shipment.

Read all instruction and study the drawing carefully before starting the assembly process.

