













ASSEMBLY INSTRUCTION

ITEM: 6820-90267-80 6/0-6/6 Panel Headboard
 6820-90267-85 6/0-6/6 Panel Headboard
 6820-90267-99 6/0-6/6 Panel Headboard
 6820-90251-80 5/0 Panel Headboard
 6820-90251-85 5/0 Panel Headboard
 6820-90251-99 5/0 Panel Headboard

Thank you for purchasing this quality product. Be sure to unpack carefully looking for small parts which may have come loose during shipment.
 Read all instruction and study the drawing carefully before starting the assembly process.

HARDWARE PACK OF HEADBOARD					PARTS LIST			
NO.	DRAWING	DESCRIPTION	SIZE	Q'TY	NO.	DRAWING	DESCRIPTION	Q'TY
A		Threaded Rod	3/8*65mm	8 PCS	1		Headboard	1 PC
B		Curved Washer	φ3/8"	8 PCS	2		Left KD Post	1 PC
C		Nut	Ø3/8"	8 PCS	3		Right KD Post	1 PC
D		Open Wrench	Ø3/8"	1 PC	4		Stretcher	1 PC
E		Bolt	5/16*65mm	14 PCS	5		Extension Block	2 PCS
F		Lock Washer	5/6"	14 PCS				
G		Flat Washer	5/16*16mm	14 PCS				
H		Allen Wrench	73*29*5mm	1 PC				

Note:

1. Height of the 6/0-6/6 Panel Headboard can be adjusted to 62" or 68" by adding or removing the extension blocks.
2. Height of the 5/0 Panel Headboard can be adjusted to 60" or 66" by adding or removing the extension blocks.

**Assembly steps - 62" height for 6/0-6/6 Panel Headboard
 60" height for 5/0 Panel Headboard**

Step 1: Attach Left KD Post (2) and Right KD Post (3) to Headboard (1) by using Threaded Rods (A), Curved Washers (B) and Nuts (C), tighten all hardware with Open Wrench (D).

Step 2: Secure the posts with Bolts (E), Lock Washers (F) and Flat Washers (G) from both sides of the Headboard, then tighten up all with Allen Wrench (H).

Step 3: Attach Stretcher (4) between Left KD Post (2) and Right KD Post (3) with Bolts (E), Lock Washers (F) and Flat Washers (G), then secure all with Allen Wrench (H).

ASSEMBLY INSTRUCTION

ITEM: 6820-90267-80 6/0-6/6 Panel Headboard
6820-90267-85 6/0-6/6 Panel Headboard
6820-90267-99 6/0-6/6 Panel Headboard
6820-90251-80 5/0 Panel Headboard
6820-90251-85 5/0 Panel Headboard
6820-90251-99 5/0 Panel Headboard

Thank you for purchasing this quality product. Be sure to unpack carefully looking for small parts which may have come loose during shipment.

Read all instruction and study the drawing carefully before starting the assembly process.

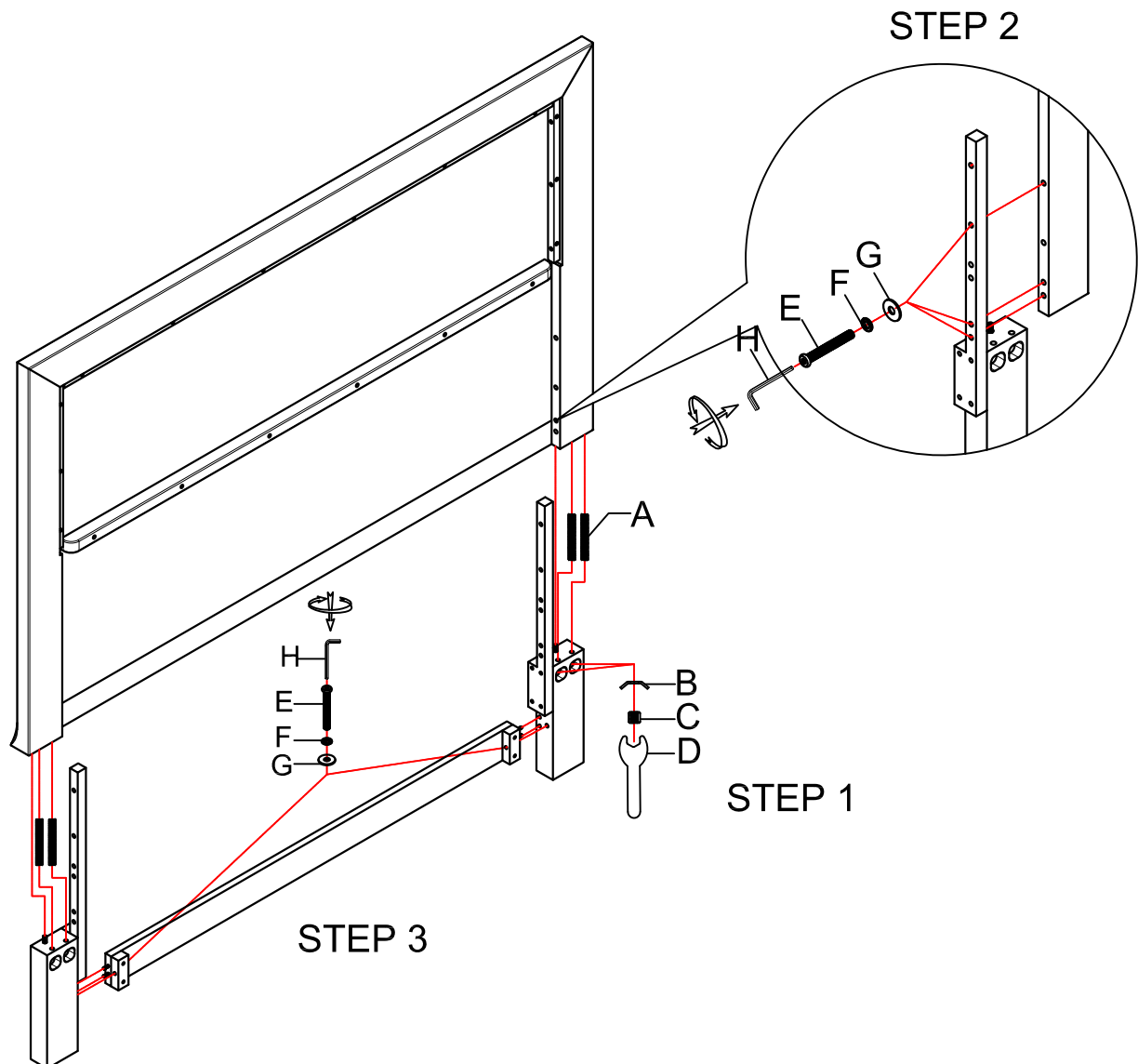

ASSEMBLY INSTRUCTION

ITEM: 6820-90267-80 6/0-6/6 Panel Headboard
6820-90267-85 6/0-6/6 Panel Headboard
6820-90267-99 6/0-6/6 Panel Headboard
6820-90251-80 5/0 Panel Headboard
6820-90251-85 5/0 Panel Headboard
6820-90251-99 5/0 Panel Headboard

Thank you for purchasing this quality product. Be sure to unpack carefully looking for small parts which may have come loose during shipment.

Read all instruction and study the drawing carefully before starting the assembly process.

**Assembly steps - 68" height for 6/0-6/6 Panel Headboard
66" height for 5/0 Panel Headboard**

Step 1: Attach Extension Blocks (5) to bottom of the Headboard.

Step 2: Attach Left KD Post (2) and Right KD Post (3) to Headboard (1) by using Threaded Rods (A), Curved Washers (B) and Nuts (C), tighten all hardware with Open Wrench (D).

Step 3: Secure the posts with Bolts (E), Lock Washers (F) and Flat Washers (G) from both sides of the Headboard, then tighten up all with Allen Wrench (H).

Step 4: Attach Stretcher (4) between Left KD Post (2) and Right KD Post (3) with Bolts (E), Lock Washers (F) and Flat Washers (G), then secure all with Allen Wrench (H).

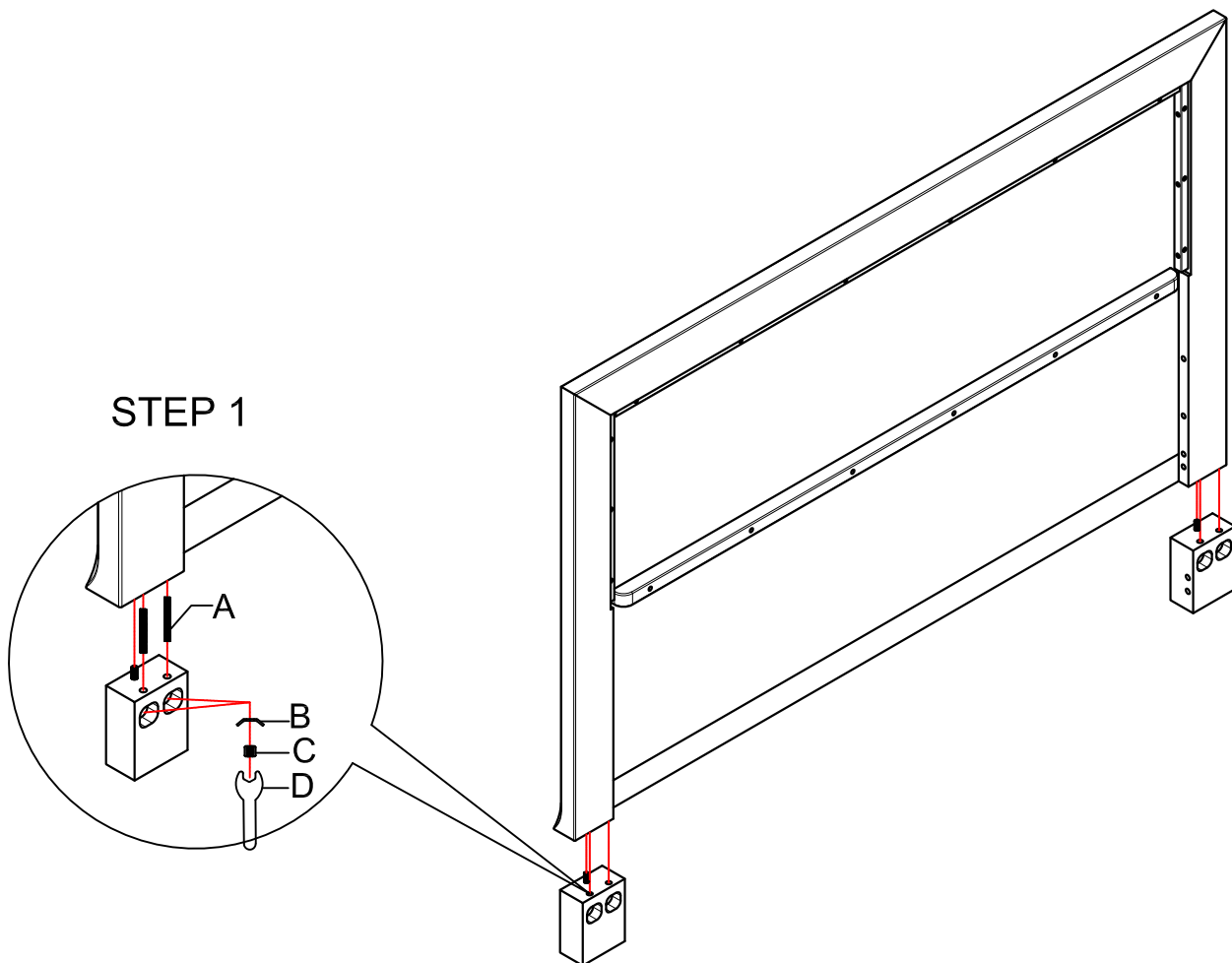

ASSEMBLY INSTRUCTION

ITEM: 6820-90267-80 6/0-6/6 Panel Headboard
6820-90267-85 6/0-6/6 Panel Headboard
6820-90267-99 6/0-6/6 Panel Headboard
6820-90251-80 5/0 Panel Headboard
6820-90251-85 5/0 Panel Headboard
6820-90251-99 5/0 Panel Headboard

Thank you for purchasing this quality product. Be sure to unpack carefully looking for small parts which may have come loose during shipment.

Read all instruction and study the drawing carefully before starting the assembly process.

