

Multi Media Wedge

Model: A136-097-041

Assembly Instructions

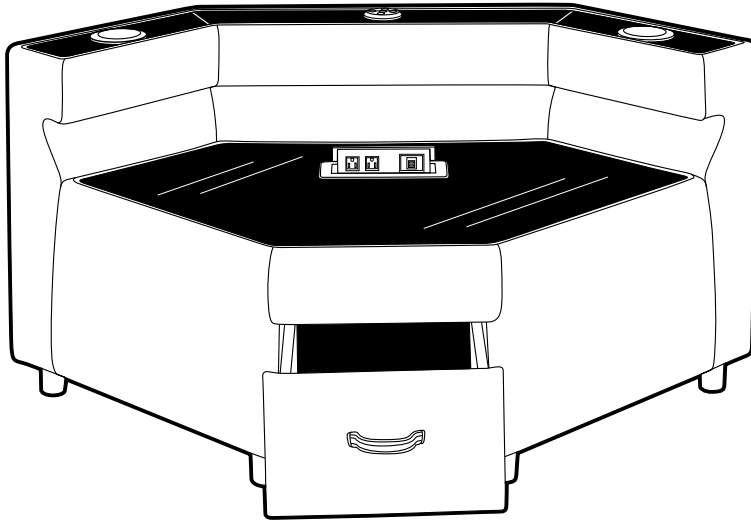

IMPORTANT, RETAIN FOR FUTURE REFERENCE: READ CAREFULLY.

Care and Cleaning

Dust often and use a vacuum cleaner crevice tool to clean seams. To maintain the fabric appearance, gently clean soiled areas with a soft cloth dampened with a mild, water based detergent. Remove all lather and wipe with a clean, damp cloth. Dry with another soft cloth by blotting the damp surface (do not rub).

Spot Cleaning Fabric: Blot any spills immediately; do not rub. Blot away the excess liquid with a clean, dry, white cloth; turning the cloth frequently.

Do not use common household cleaners, solvents, or dry cleaning fluids on fabric furniture. These cleaners may cause damage.

Do not use or place sharp objects on upholstered furniture.

Do not place furniture in direct sunlight and keep furniture at least 60 cm / 2 ft from heat sources to avoid fading.

Contents of Cartons

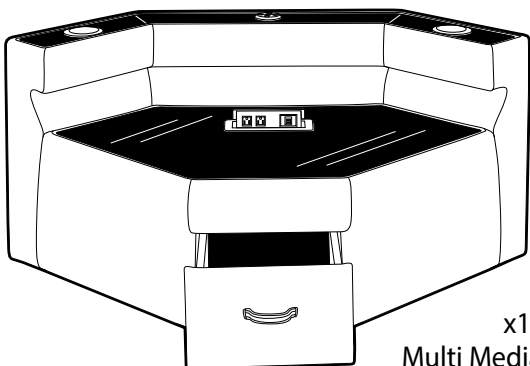

x1
Multi Media Wedge

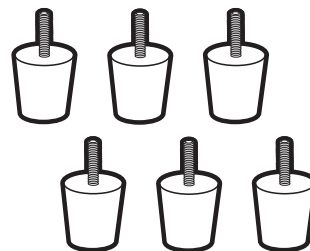

x6
Legs

Multi Media Wedge

Model: A136-097-041

Assembly Instructions

Attaching the Legs

Locate the legs inside a zippered area on the bottom of the wedge.

Attach the 6 legs by screwing them into the bottom of the wedge as shown.

Also in the zippered area is the power transformer for the bluetooth controls and the electrical cord for the electrical outlets and USB ports.

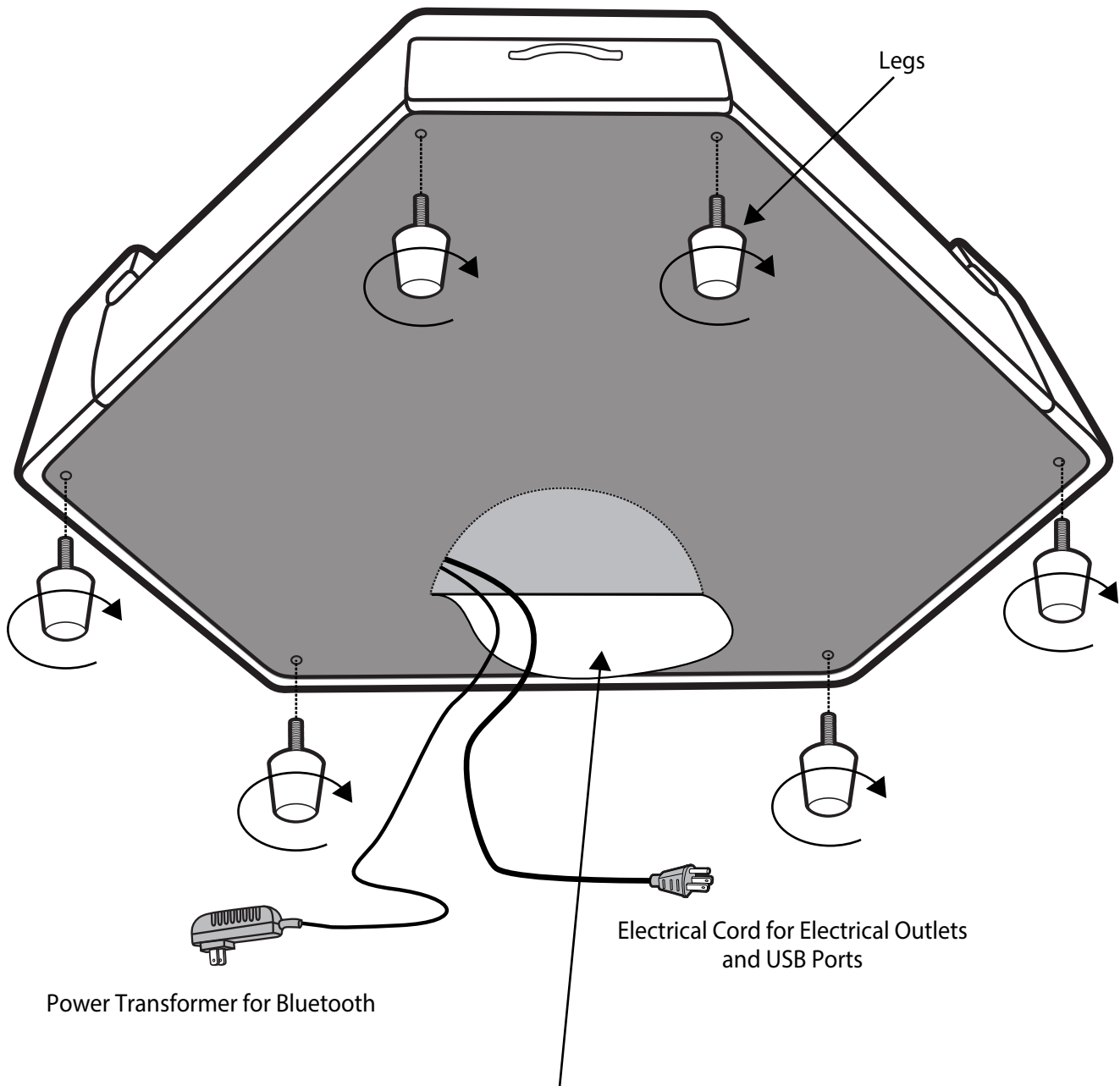

Zippered area under the wedge holds the Legs, Power Transformer and Electrical Cord

Multi Media Wedge

Model: A136-097-041

Assembly Instructions

Bluetooth Controls

NOTE: Have your Bluetooth device (phone, tablet, mp3 player, etc.) turned on before starting.

STEP 1: Press the POWER  button. Button will glow red.

STEP 2: Press and hold the POWER  button. The other buttons will glow blue. The Power button will blink red. This indicates the system is searching for an available Bluetooth signal.

STEP 3: Tap the settings button on the phone, tablet, mp3 player etc. Tap on the Bluetooth setting. When your device finds the chairs system the name will appear on your device as eMoMo. If required, enter password 0000. The chair will give a signal sound to indicate the pairing was successful.





STEP 4: Lightly press the POWER  button to begin play or stop of an audio file.

STEP 5: Press the POWER  button for 2 seconds to turn the system off

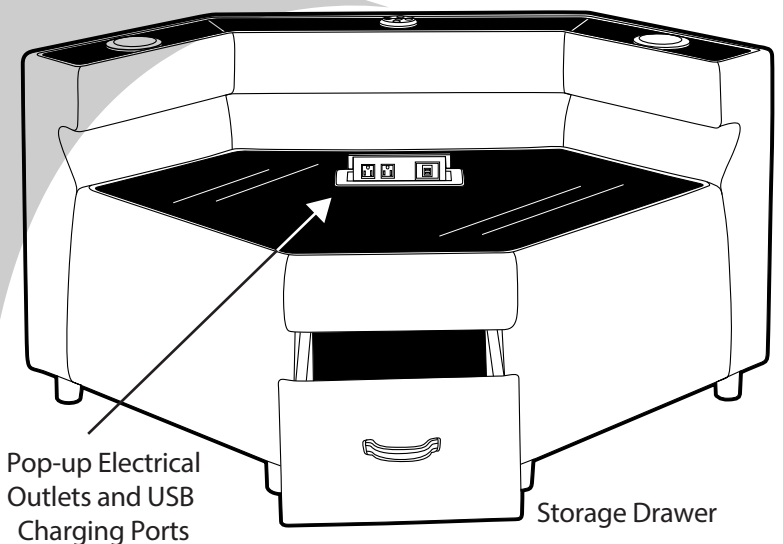

Bluetooth Controls



	Power On/Off, Play/Stop
	Fast Forward/Next Track
	Rewind/Previous Track
	Increase Volume
	Decrease Volume

Multi Media Wedge

Model: A136-097-041

Assembly Instructions

Light

Press the Light Button located under the center of the back rail (Under the Bluetooth Controls) to turn the lights ON.

Press the Light Button again to shut the lights off.

