

PALECEK™

601 PARR BOULEVARD, RICHMOND, CA 94801







ONSHORE PLATFORM BED INSTALLATION INSTRUCTIONS

These instructions are provided for your convenience. It is very important that they are read carefully and completely before beginning installation of this item. (Applies to items 7569-03, 7565-03)



ITEM 7569-03

PARTS:

NO.	DRAWING	DESCRIPTION	SIZE	QTY
1		Stud Bolt	5/16 X 90 mm	8
2		Half Moon Washer		8
3		Hex Nut	M5/16	8
4		Spring Washers	M5/16	8
5		Screw	JP 8 x 1 1/4"	4
6		Wrench		1

TO ASSEMBLE:

1. Unbox all components onto a non scratching surface.
2. Clear all packaging but do not discard until item is fully assembled.
3. Insert Stud Bolt (1) into the four threaded holes at base of Headboard. Tighten manually.
4. Align holes at end of Side Rail onto the Stud Bolts, ensuring that the bed slat lip is at the bottom. Slide Side Rail until it touches Headboard.
5. Insert Half Moon Washer (2), Spring Washer (3), and Hex Nut (4) over ends of Stud Bolt (1). Use Wrench (6) to tighten. Do not over tighten.
6. Repeat steps 4-5 for the remaining side rail.
7. Insert Stud Bolt (1) into the four threaded holes at base of Footboard. Tighten manually.
8. Align holes at end of Side Rail onto the Stud Bolts. Slide Side Rail until it touches Footboard.
9. Insert Half Moon Washer (2), Spring Washer (3), and Hex Nut (4) over ends of Stud Bolt (1). Use Wrench (6) to tighten. Do not over-tighten.
10. Repeat steps 8-9 for remaining Side Rail.
11. Install Center Support Rail with feet facing down, by snapping into end clips on Headboard and Footboard. Raise or lower the adjustable glides on the feet until both make contact with the floor.
12. Place bed slat roll onto bed slat support rails and unroll until it lays flat. Using included screws (5), screw down bedslat in the far four corners until secure.
13. Assembly complete.

CARE:

Dust with a soft dry cloth. Do not use cleaning solutions or abrasives.

PALECEK™

601 PARR BOULEVARD, RICHMOND, CA 94801

ONSHORE PLATFORM BED INSTALLATION INSTRUCTIONS

These instructions are provided for your convenience. It is very important that they are read carefully and completely before beginning installation of this item. (Applies to items 7569-03, 7565-03)

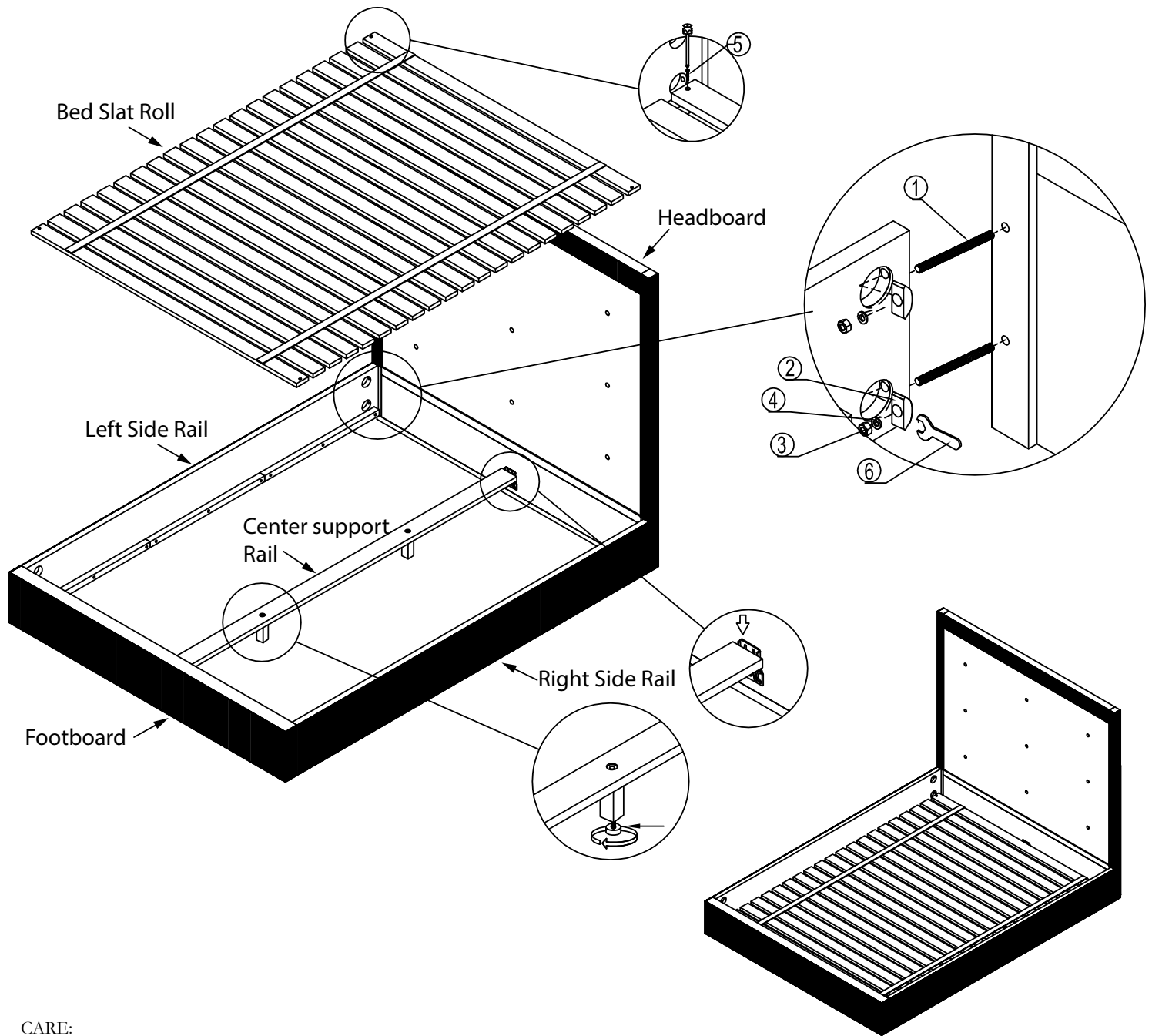

CARE:

Dust with a soft dry cloth. Do not use cleaning solutions or abrasives.

T. 800.274.7730 | F. 510.234.7234

PALECEK.COM