

PALECEK™

601 PARR BOULEVARD, RICHMOND, CA 94801

ST. HELENA BED ASSEMBLY INSTRUCTIONS

These instructions are provided for your convenience. It is very important that they are read carefully and completely before beginning installation of this item. (Applies to item 7527-79). Installation by two (2) persons recommended.



PARTS:

- A) HEADBOARD (1x)
- B) FOOTBOARD (1x)
- C) WRENCH (1x)
- D) HEX BOLT (8x)
- E) WASHER (8x)
- F) LOCK WASHER (8x)
- G) ALLEN WRENCH (1x)
- H) PANHEAD SCREW (8x)
- I) SIDE RAILS (2x)
- J) BED SLAT ROLL (1x)
- K) CENTER SLAT SUPPORT RAIL (1x)
- L) CENTER SUPPORT BRACKET (2x)

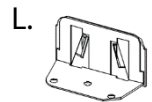
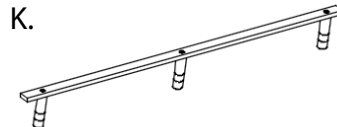
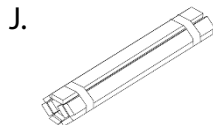
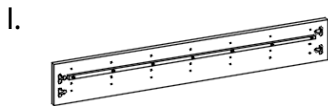
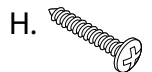
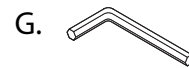
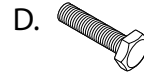
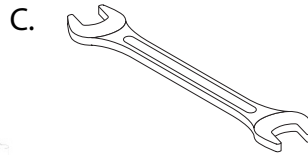
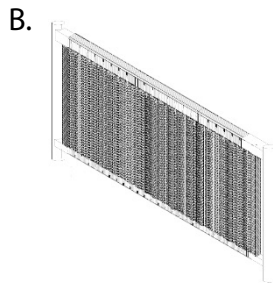
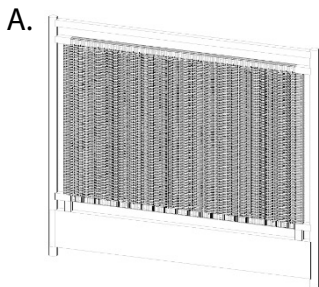

PALECEK™

601 PARR BOULEVARD, RICHMOND, CA 94801

ST. HELENA BED ASSEMBLY INSTRUCTIONS

These instructions are provided for your convenience. It is very important that they are read carefully and completely before beginning installation of this item.(Applies to item 7527-79). Installation by two (2) persons recommended.

TOOLS NEEDED:

Phillips head Screwdriver (not included), Wrench (included), Allen Wrench (Included).

TO ASSEMBLE:

Step 1)-Unpack box and ensure all parts are accounted for. Do not discard packaging until bed is completely assembled.

Step 2)-With the Headboard (A) and Footboard (B) parallel to each other, place the Side Rails (I) in between them with adjustable bed slat support rails facing internally.

Step 3)-Insert Hex Bolt (D) through Lock Washer (F) and Washer (E), then through slots at headboard ends of Side Rails (I), into holes in base of Headboard (A). Tighten with included Wrench (C). Repeat steps to complete attachment of Side Rails (I) to Headboard (A). See Fig A.

Step 4)-Insert Hex Bolt (D) through Lock Washer (F) and Washer (E), then through slots at footboard ends of Side Rails (I), into holes in base of Footboard (B). Tighten with included Wrench (C). Repeat steps to complete attachment of Side Rails (I) to Footboard (B).

Step 5)-Adjust Bed Slat Support Cleat height by removing existing Allen Bolts with included Allen Wrench (G), aligning the Cleat over desired holes and inserting Allen Bolts. Tighten accordingly. See Fig B.

Step 6)-Establish the height of the Center Support Rail (K) to match the bed slat support Side Rail Cleat (I), by removing and adjusting center leg bracket on headboard/footboard as needed. See Fig C.

Step 7)-Attach Center Support Rail (K) to Headboard (A) and Footboard (B) by using the Center Support Bracket (L) and Pan Head Screws (H). Use a Phillips head screwdriver to tighten screws. Ensure they are installed at same height as Side Rail (I) cleats.

Step 8)-Place Bed Slat Roll (J) onto Side Rail (I) cleats and Center Support Rail (K). Affix Bed Slat Roll (J) using Pan Head Screws (H) by inserting the screws into the pre-drilled holes. Use a Phillips head screwdriver to tighten screws.

Step 8)-The bed has adjustable floor glides. If the bed is on an uneven floor surface, turn floor glides clockwise or counter-clockwise until all floor glides make contact with the floor.

Step 8)-Assembly complete.

PALECEK™

601 PARR BOULEVARD, RICHMOND, CA 94801

ST. HELENA BED ASSEMBLY INSTRUCTIONS

These instructions are provided for your convenience. It is very important that they are read carefully and completely before beginning installation of this item. (Applies to item 7527-79). Installation by two (2) persons recommended.

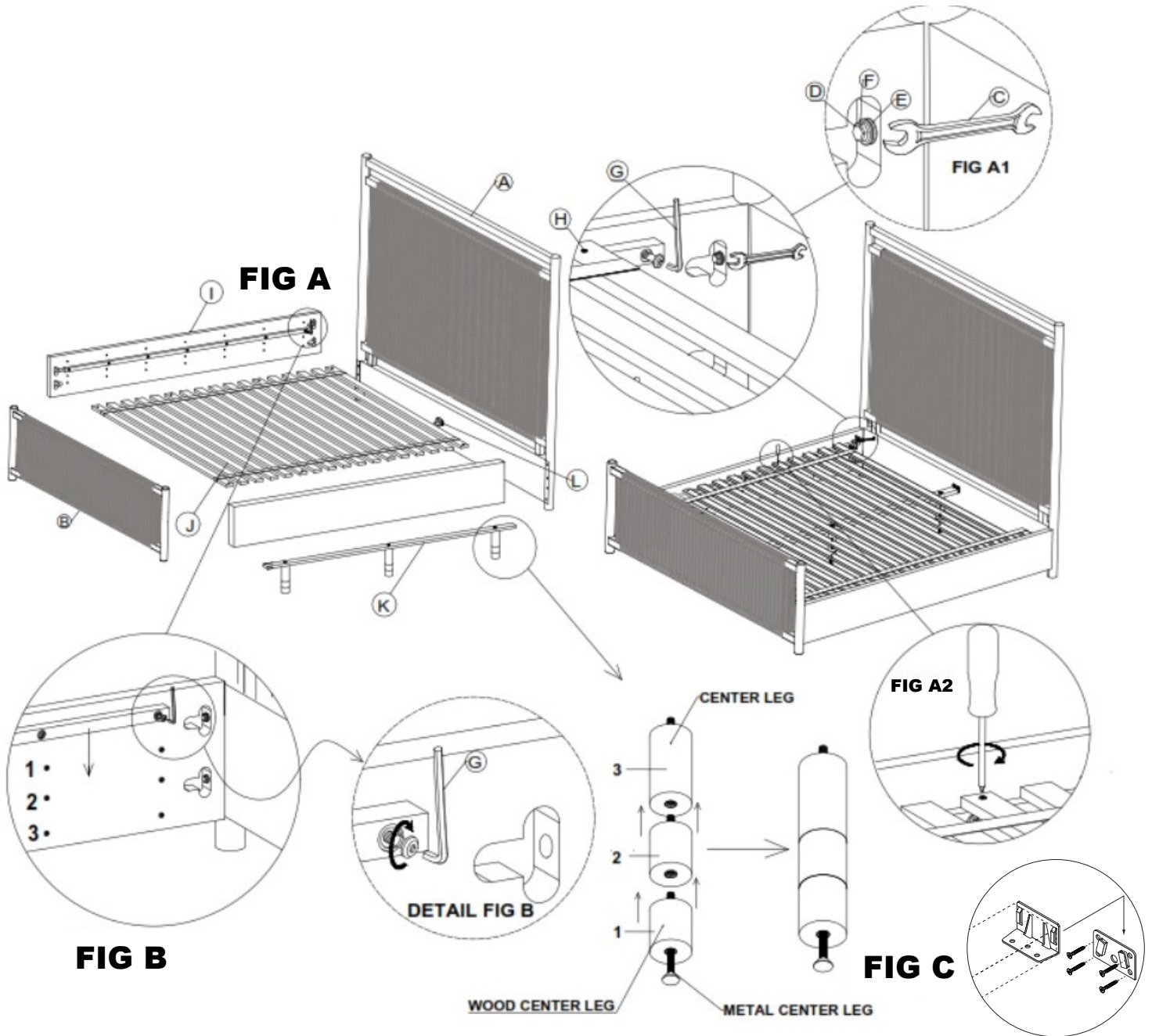

CARE:

Dust with a soft dry cloth. Wipe up spills immediately. Clean with damp cloth. Do not use cleaning solutions or abrasives.