

# PALECEK

601 PARR BLVD. RICHMOND, CA 94801

## 738396 - ASSEMBLY INSTRUCTIONS

### FURNITURE TIPPING RESTRAINT

**WARNING:** This product is only a deterrent. It is not a substitute for proper adult supervision. Manufacturer assumes no liability for improper installation or excessive loads placed on screws, brackets or straps.

Young children may be injured by tipping furniture and the use of a tipping restraint is highly recommended.

When properly installed, this restraint will provide protection against tipping of furniture. This tipping restraint **MUST** be secured to a wall-stud or wall structure of similar strength.

---

Hardware included: (2x) Metal cord 160x10x4mm    (4x) Wall plug 40x13mm    (4x) Screw M4x30mm  
(4x) Hair pin 10x30mm    (4x) Screw M4x15mm    (2x) Adjustable shelf  
(4x) Clevis pin 9x25mm    (8x) Screw M4x15mm    (2x) Alen Bolt M6x35mm(Re-Assembly)  
(4x) Bracket 52x16x17mm    (8x) Shelf Support 29x13x17mm

Note: For safe mounting it is essential to use the proper hardware for your wall type. The included hardware is for stud mounting only. If the mounting bracket cannot be secured to a wall stud because of inappropriate spacing and/or because you have a different wall type (e.g., plaster, concrete, brick etc..) please consult your local hardware store for fastener advice.

To install:

1. Unpack all parts and place them on a protected work surface.
2. Attach 1 metal bracket near the middle-top back edge of the furniture piece by using shorter screws. (FIGURE 2)
3. Determine the final position of the furniture piece. Position the metal bracket on the wall stud approximately 2" below the metal bracket mounted to the back of the furniture. Mark and drill pilot hole into the center of stud with 3/32" drill bit. Attach metal bracket into the wall by using screws and Wall plug. (FIGURE 1)
4. Move the furniture into position with the brackets on the back edge are in line with the brackets in the wall.
5. Insert the clevis pin through holes on brackets and hole on metal cord. Using hair pin to go through small hole on clevis pin to lock it. (FIGURE 2)
6. Repeat above step to attach the end of metal cord to the metal bracket on the wall.
7. Check to make sure the metal cord are securely laced and locked to the brackets.(FIGURE 3)
8. Insert the Shelf support through holes side of the cabinet. Place Adjustable shelf on shelf support and fix with Screw M4 x 15mm. (FIGURE 4)
9. When the dresser is installed in position, the levelers at the bottom of the feet may need adjusting to ensure the cabinet is level and the doors line up and function correctly. (FIGURE 5)

Note: If you must move the furniture item, you can release the strap by depressing the lever arm located at its buckle and simultaneously withdrawing the strap from the buckle. Make sure to reconnect the strap once the furniture item is returned to its previous position.

## 738396 - ASSEMBLY INSTRUCTIONS

### FURNITURE TIPPING RESTRAINT

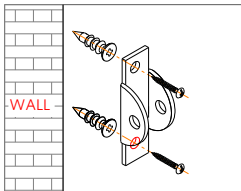

Figure 1

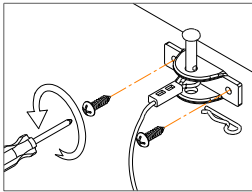

Figure 2

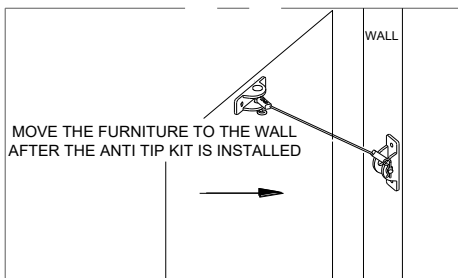
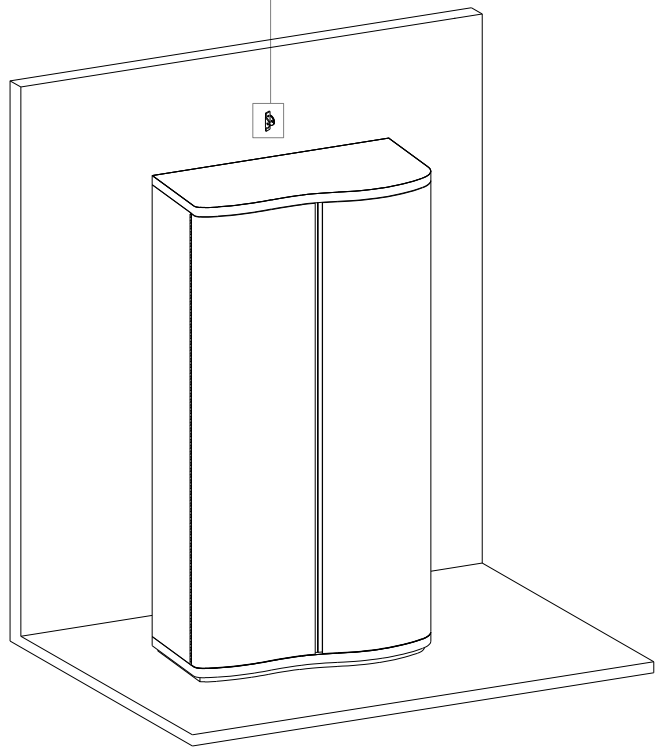

Figure 3



# PALECEK

601 PARR BLVD. RICHMOND, CA 94801

## 738396 - ASSEMBLY INSTRUCTIONS

Figure 4

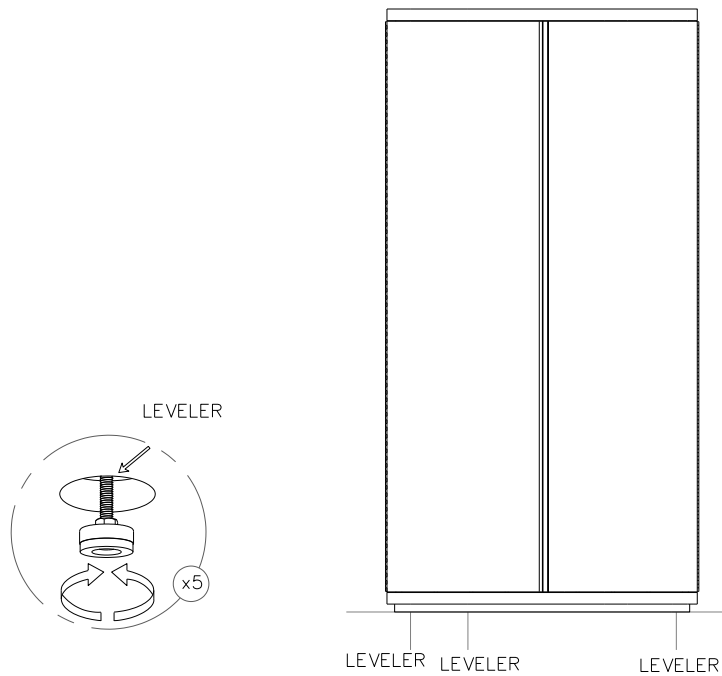
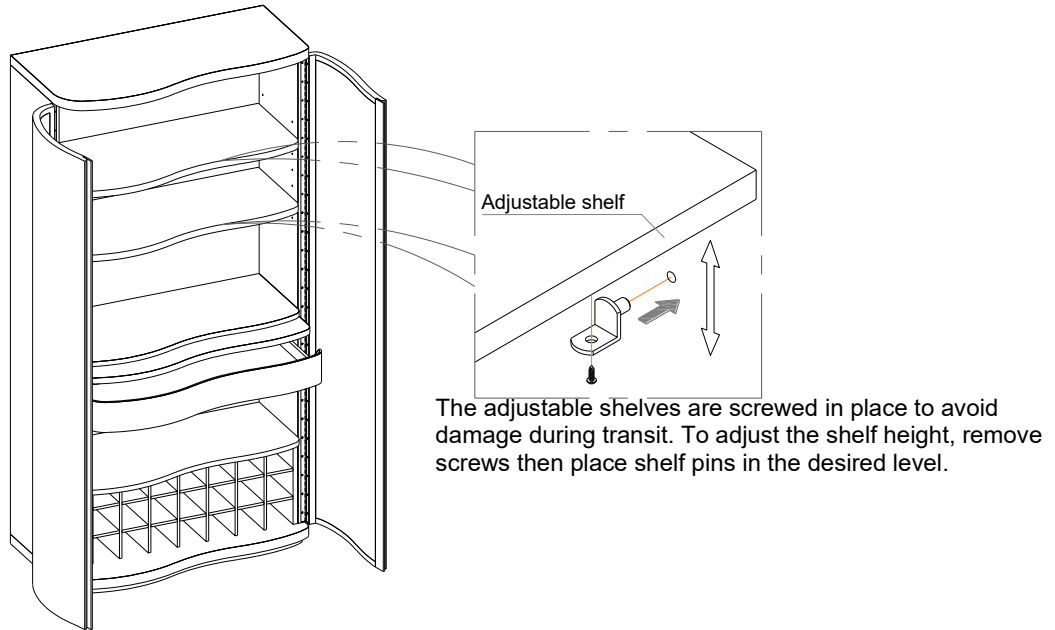

Figure 5

# PALECEK

601 PARR BLVD. RICHMOND, CA 94801

## 738396 - ASSEMBLY INSTRUCTIONS

INSTRUCTIONS FOR DRAWER  
STEP 1: DRAWER REMOVAL INSTRUCTIONS

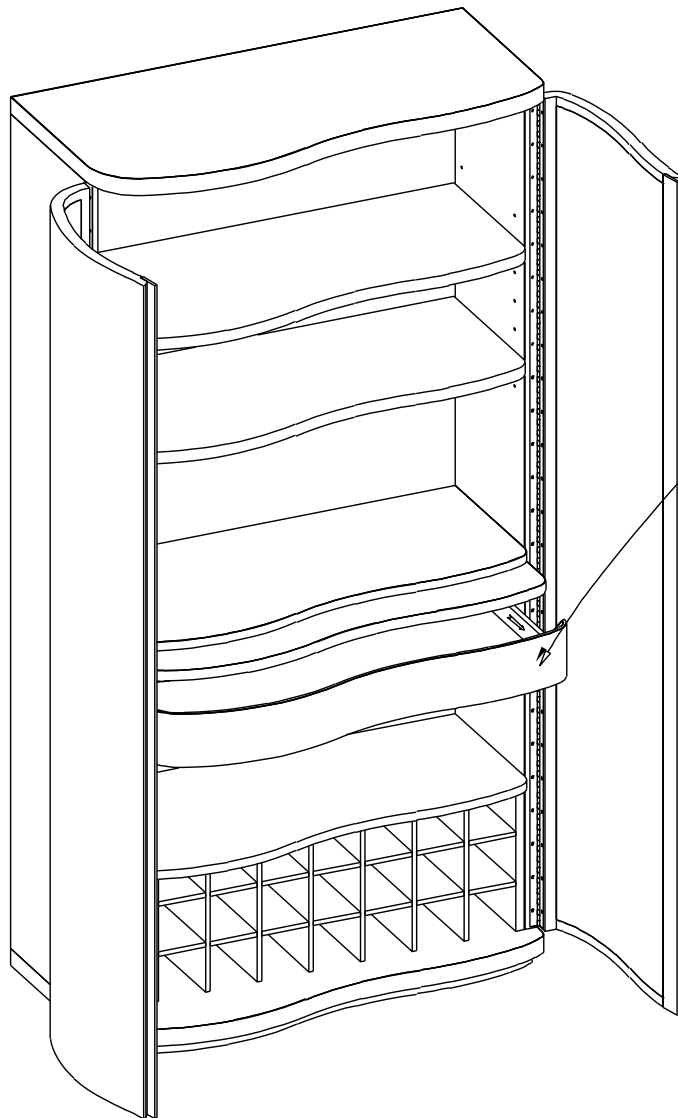
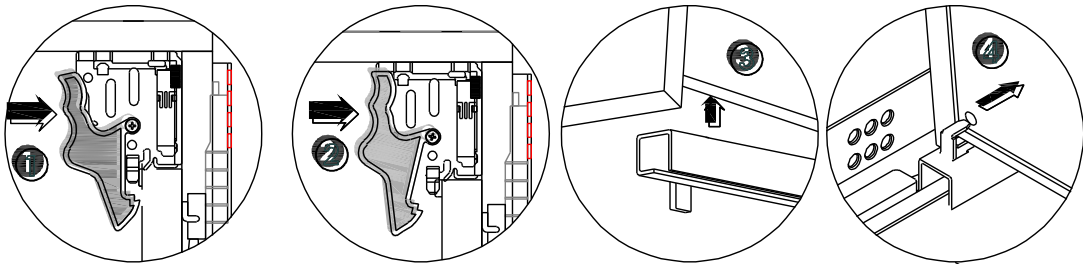

# PALECEK

601 PARR BLVD. RICHMOND, CA 94801

## 738396 - ASSEMBLY INSTRUCTIONS

### STEP 2: DRAWER ASSEMBLY INSTRUCTIONS

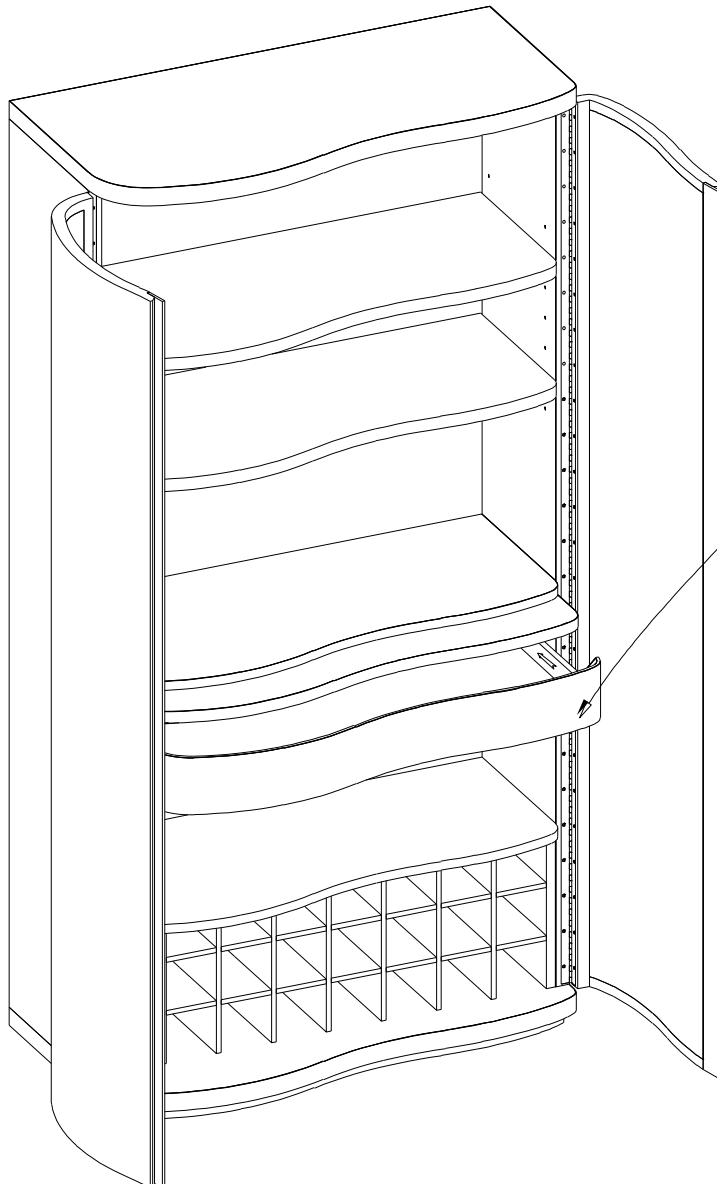
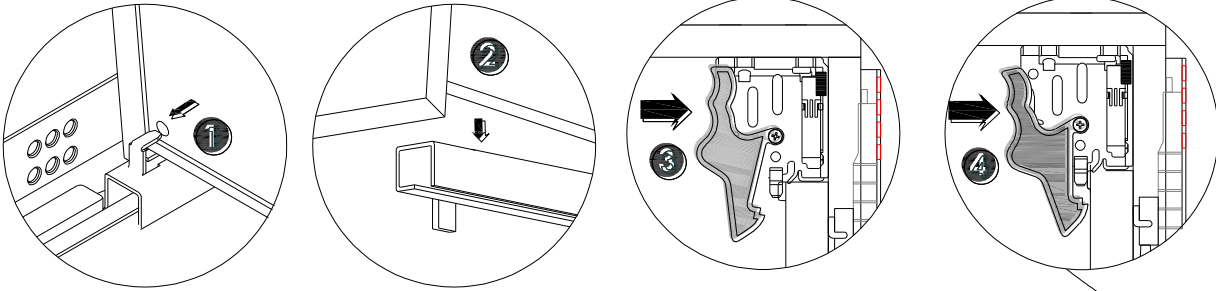

# PALECEK

601 PARR BLVD. RICHMOND, CA 94801

## 738396 - ASSEMBLY INSTRUCTIONS

### FURNITURE TIPPING RESTRAINT

#### STEP 3: DRAWER HEIGHT ADJUSTMENT INSTRUCTIONS

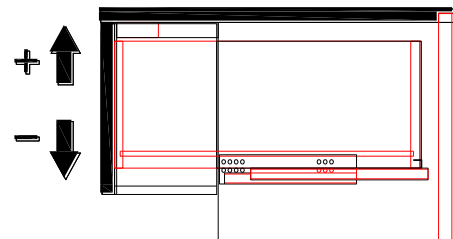
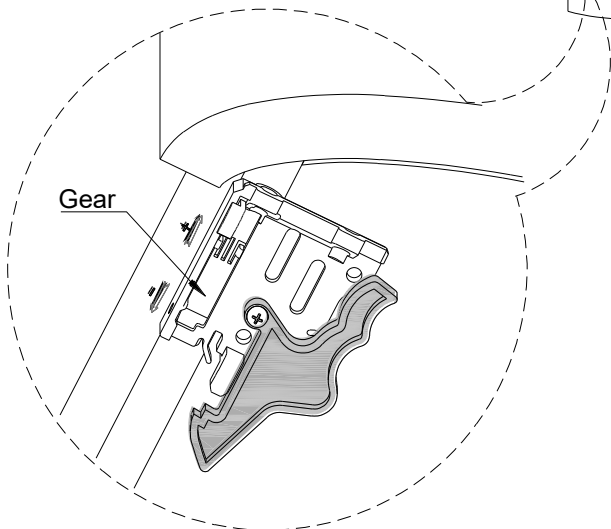
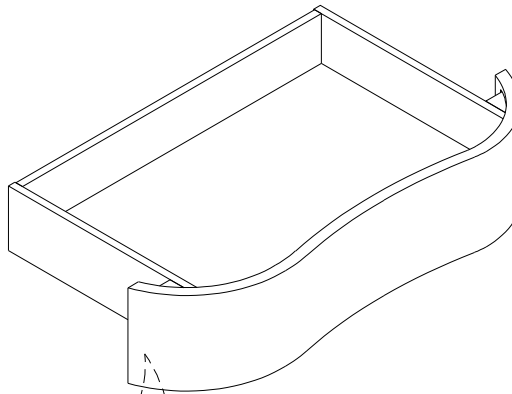
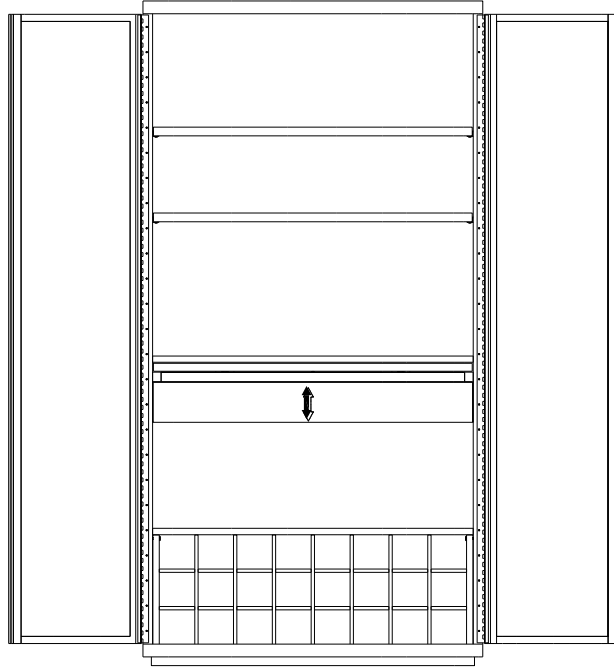

# PALECEK

601 PARR BLVD. RICHMOND, CA 94801

## 738396 - ASSEMBLY INSTRUCTIONS

INSTRUCTIONS FOR THE WINE GRID REMOVAL INSTRUCTIONS

