

PALECEK

601 PARR BLVD. RICHMOND, CA 94801

732096 - ASSEMBLY INSTRUCTIONS FURNITURE TIPPING RESTRAINT

WARNING: This product is only a deterrent. It is not a substitute for proper adult supervision. Manufacturer assumes no liability for improper installation or excessive loads placed on screws, brackets or straps.

Young children may be injured by tipping furniture and the use of a tipping restraint is highly recommended.

When properly installed, this restraint will provide protection against tipping of furniture. This tipping restraint **MUST** be secured to a wall-stud or wall structure of similar strength.

Hardware included: (1x) Metal cord 160 x10 x4mm (2x) Wall plug 40 x13mm
(2x) Hair pin 10 x 30mm (2x) Screw M4 x 30 mm
(2x) Clevis pin 9 x 25mm (2x) Screw M4 x15mm
(2x) Bracket 52 x16 x17mm

Note: For safe mounting it is essential to use the proper hardware for your wall type. The included hardware is for stud mounting only. If the mounting bracket cannot be secured to a wall stud because of inappropriate spacing and/or because you have a different wall type (e.g., plaster, concrete, brick etc..) please consult your local hardware store for fastener advice.

To install:

1. Unpack all parts and place them on a protected work surface.
2. Attach 1 metal bracket near the middle-top back edge of the furniture piece by using shorter screws. (FIGURE 2)
3. Determine the final position of the furniture piece. Position the metal bracket on the wall stud approximately 2" below the metal bracket mounted to the back of the furniture. Mark and drill pilot hole into the center of stud with 3/32" drill bit. Attach metal bracket into the wall by using screws and Wall plug. (FIGURE 1)
4. Move the furniture into position with the brackets on the back edge are in line with the brackets in the wall.
5. Insert the clevis pin through holes on brackets and hole on metal cord. Using hair pin to go through small hole on clevis pin to lock it. (FIGURE 2)
6. Repeat above step to attach the end of metal cord to the metal bracket on the wall.
7. Check to make sure the metal cord are securely laced and locked to the brackets.(FIGURE 3)
8. When the cabinet is installed in position, the levelers at the bottom of the feet may need adjusting to ensure the dresser is level and the drawers line up and function correctly. (FIGURE 4)

Note: If you must move the furniture item, you can release the strap by depressing the lever arm located at its buckle and simultaneously withdrawing the strap from the buckle. Make sure to reconnect the strap once the furniture item is returned to its previous position.

PALECEK

601 PARR BLVD. RICHMOND, CA 94801

732096 - ASSEMBLY INSTRUCTIONS

FURNITURE TIPPING RESTRAINT

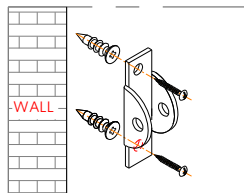

Figure 1

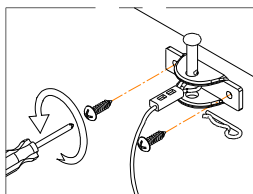

Figure 2

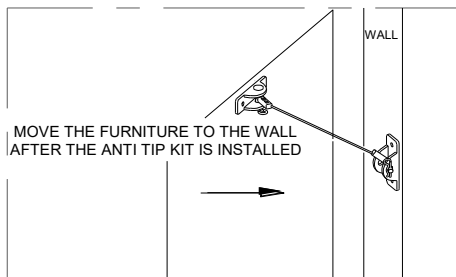
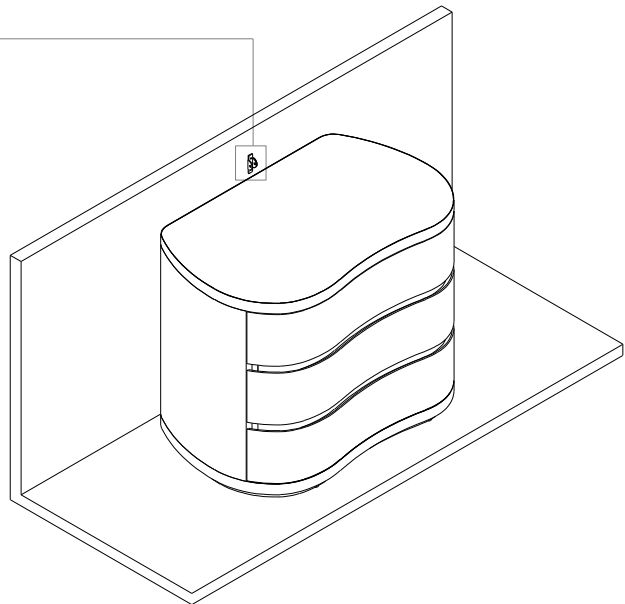

Figure 3



PALECEK

601 PARR BLVD. RICHMOND, CA 94801

732096 - ASSEMBLY INSTRUCTIONS

Figure 4

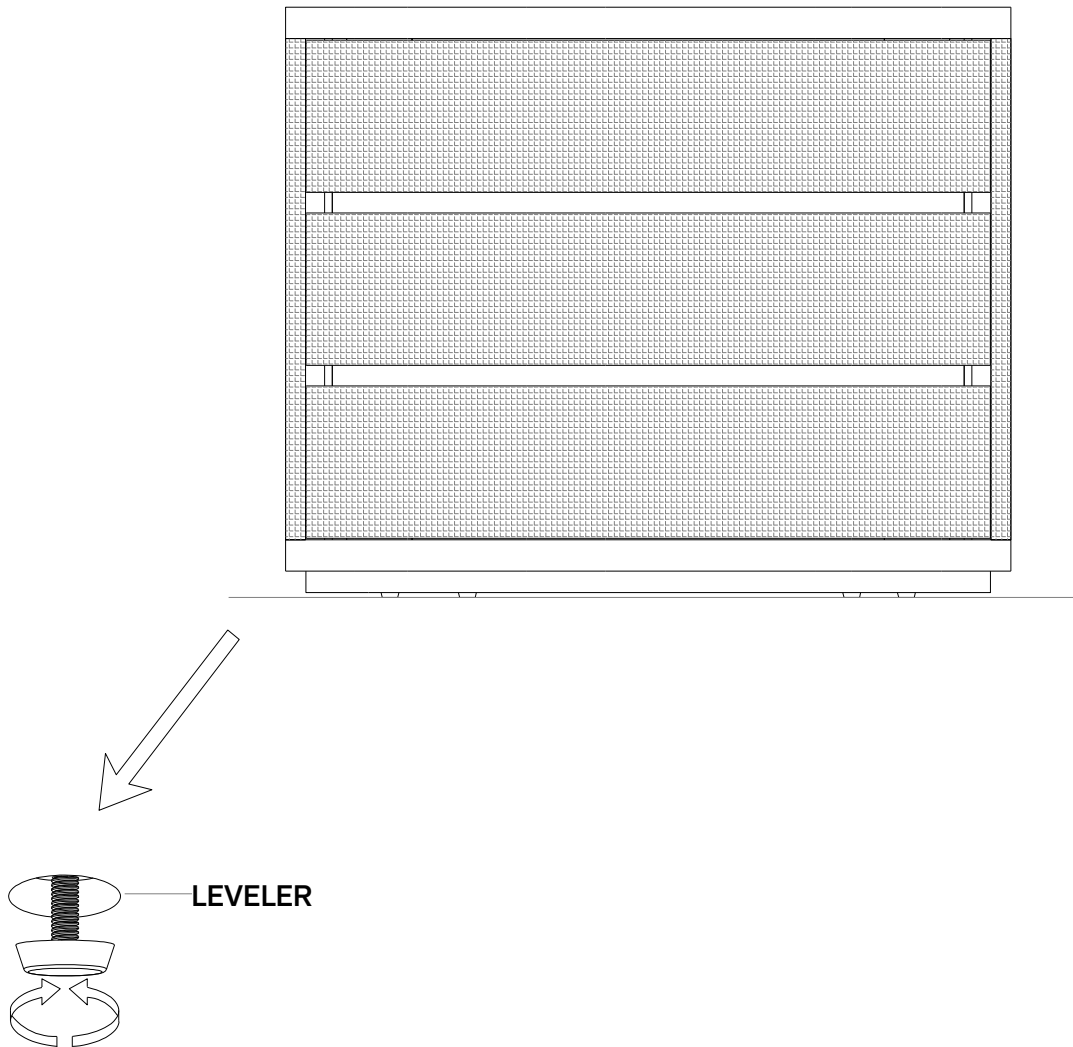

PALECEK

601 PARR BLVD. RICHMOND, CA 94801

732096 - ASSEMBLY INSTRUCTIONS

INSTRUCTIONS FOR DRAWER

STEP 1: DRAWER REMOVAL INSTRUCTIONS

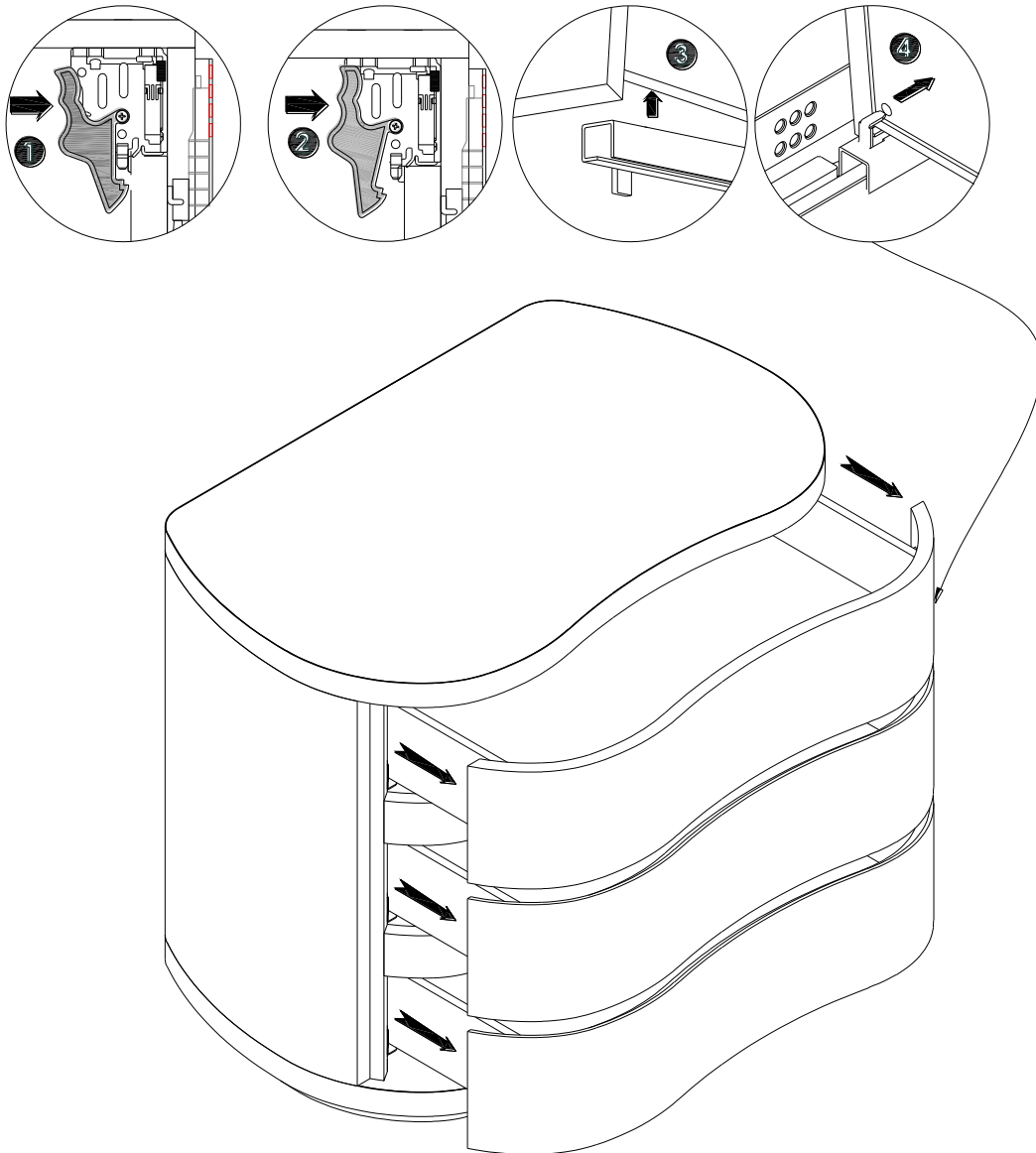

PALECEK

601 PARR BLVD. RICHMOND, CA 94801

732096 - ASSEMBLY INSTRUCTIONS

STEP 2: DRAWER ASSEMBLY INSTRUCTIONS

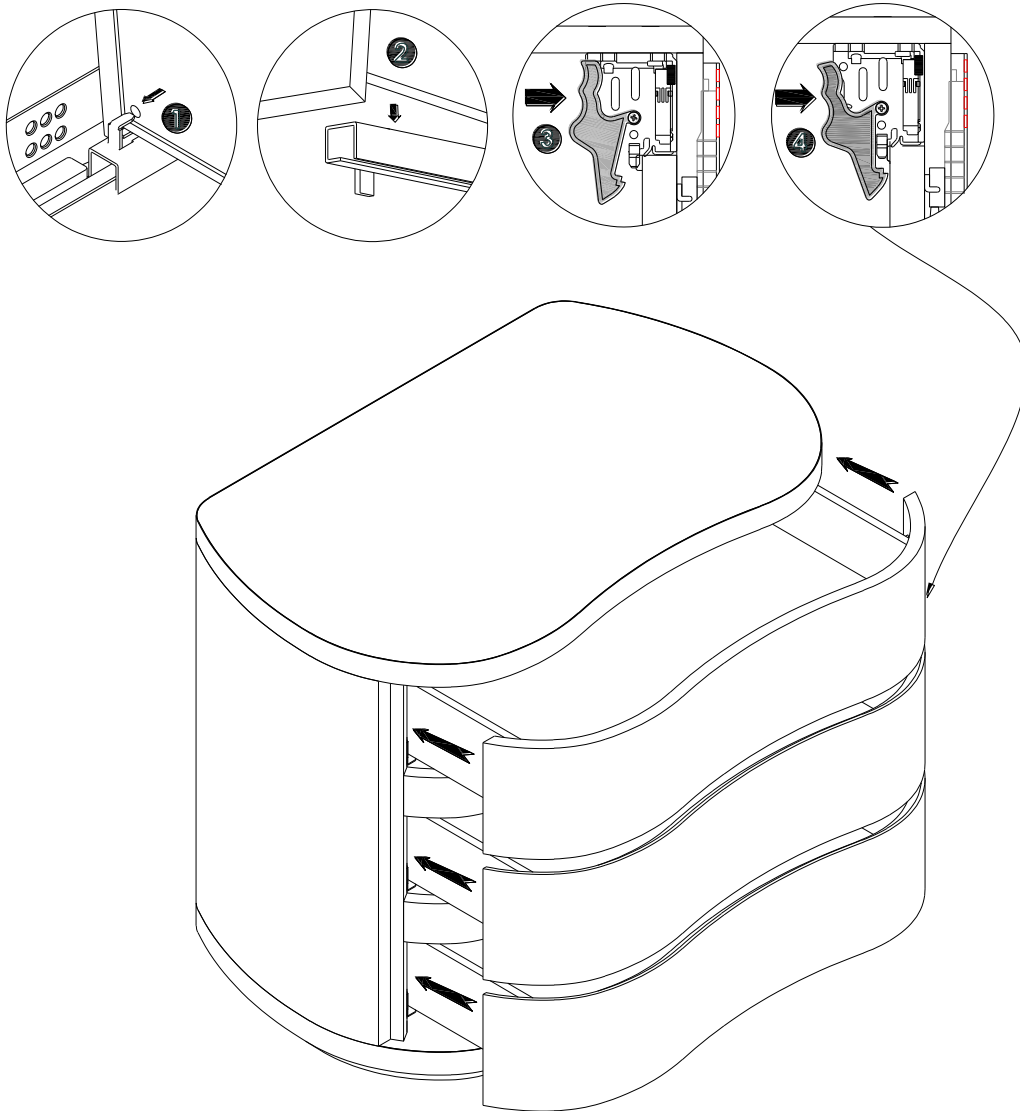

PALECEK

601 PARR BLVD. RICHMOND, CA 94801

732096 - ASSEMBLY INSTRUCTIONS

STEP 3: DRAWER HEIGHT ADJUSTMENT INSTRUCTIONS

