

BINK[®] 1025

MOBILE LAPTOP TABLE

USER MANUAL

LET'S GET STARTED.

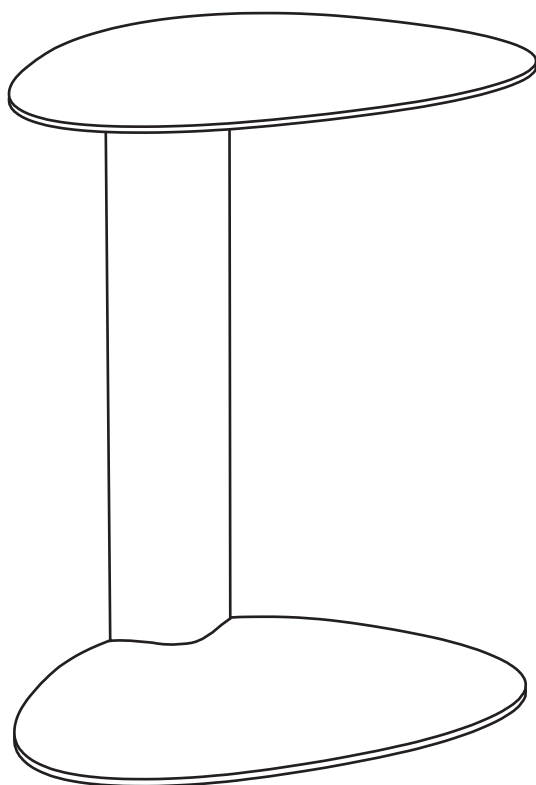

DESIGN MATTHEW WEATHERLY

BDi

BDIUSA.COM

Congratulations on the purchase of your Bink Mobile Laptop Table from BDI. Thoughtfully designed and carefully engineered, Bink is built to deliver years of everyday convenience and enjoyment.

This user manual provides assembly instructions, care information, and helpful details to help you get the most from your product. Please save it for future reference.

Bink has been designed for simple assembly. Follow the instructions carefully to help prevent damage during setup.

ENJOY!

HARDWARE AND COMPONENTS

Unpack and identify all components listed below. Assemble the product on a non-marring surface, such as carpet or a protective mat. If any hardware is missing, contact BDI Customer Service at customerservice@bdiusa.com. For all other concerns, please contact your authorized BDI retailer.

IMPORTANT: Do not use power tools during assembly.

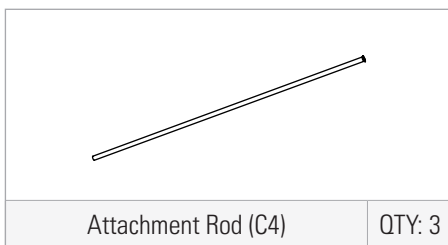
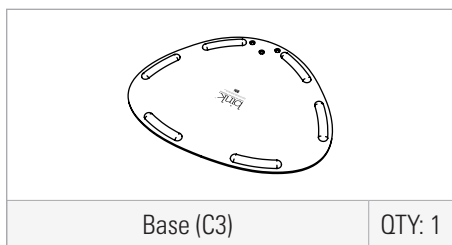
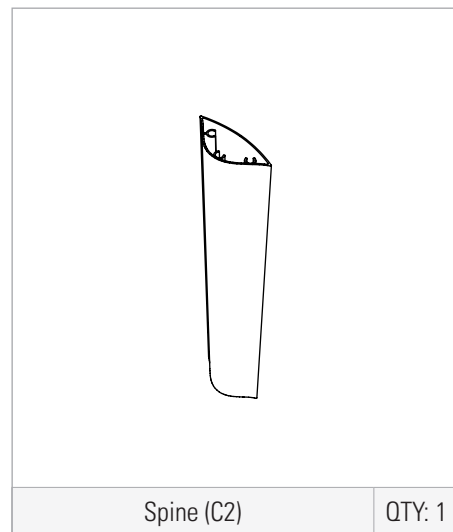
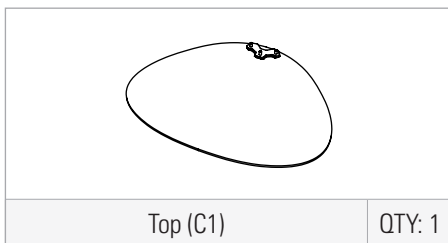
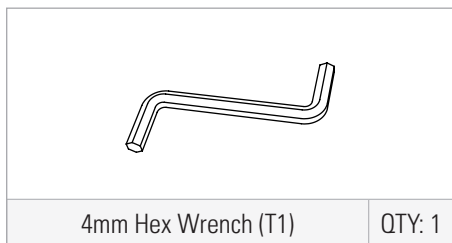

Place the **Top (C1)** upside down on a non-marring surface. With the assistance of another person, position the **Spine (C2)** and **Base (C3)** as shown. Insert the three **Attachment Rods (C4)** and loosely secure them using the provided **4mm Hex Wrench (T1)**. Once all three rods are in place, tighten each one securely, then rotate the table onto its base.

	HEX WRENCH – T1	QTY 1
--	-----------------	----------



WARNING: Do not sit or stand on table.

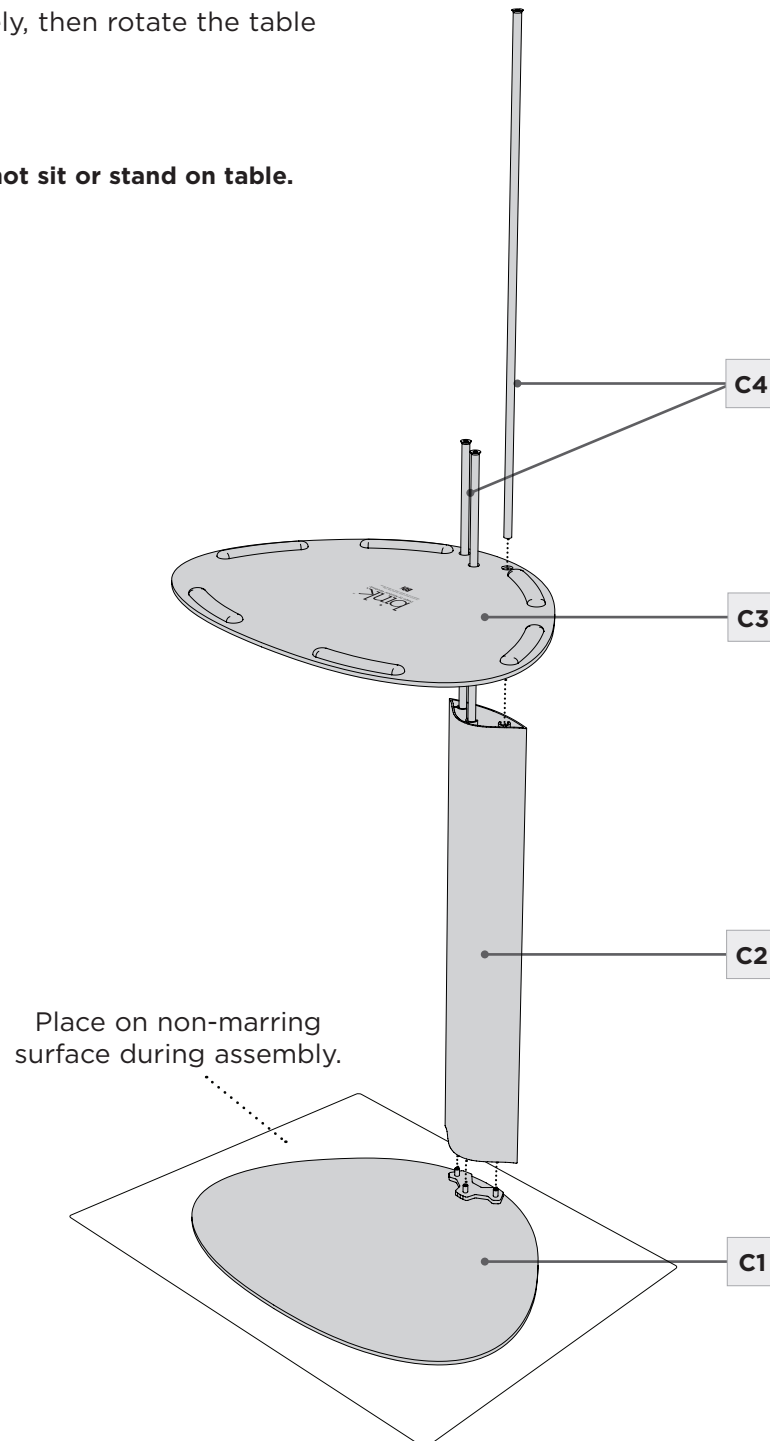

CARE & MAINTENANCE

Your BDI furniture is constructed with carefully selected materials and is designed to provide lasting performance. Regular care will help maintain its appearance and longevity. Here are some general tips for taking care of BDI furniture. Your product surfaces may vary.

METAL, PORCELAIN, & PAINTED SURFACES

Surfaces should be cleaned with a slightly damp (not saturated) cloth or paper towel. If moisture remains, dry the surface with another cloth. If needed, a gentle, non-abrasive cleanser may be used, but be sure to wipe away all cleaner residue and dry the surface with a cloth.

WARRANTY

BDI warrants to the original purchaser that for the below-stated warranty term, BDI will replace any product, part, or component covered by this warranty that fails under normal use as a result of a defect in material or workmanship. The decision to replace a complete product versus the part or component in question will be at BDI's sole discretion.

Residential Use: BDI Furnishings carry warranty coverage for three (3) years from the date of product delivery, as shown on your sales receipt/documentation. Select chairs carry coverage for five (5) years from the date of product delivery.

Commercial Use: BDI Furnishings carry warranty coverage for one (1) year from the date of product delivery, as shown on your sales receipt/documentation. Select chairs carry coverage for five (5) years from the date of the product delivery, based on an 8-hour daily use pattern.

BDI reserves the right to refine or update its warranty from time to time. See the complete and latest warranty document at www.bdiusa.com/warranty.

PRODUCT REGISTRATION

Registering your new BDI product allows us to share important product updates, service information, and helpful care tips.

Register today for a **chance to win a free BINK table** from BDI. www.bdiusa.com/register

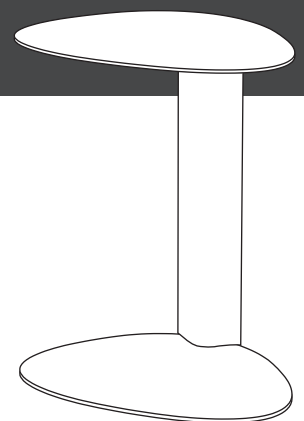

BDIUSA.COM

These distinctive product configurations are protected by US and international patents, trade dress, and/or copyright laws. Bink & BDI are trademarks of Becker Designed, Inc. All rights reserved. ©2026, BDI | V.01.05.2026

Made in China.