



■ Vers. 480+F83



■ Vers. 480+F83



■ Vers. 480+F83



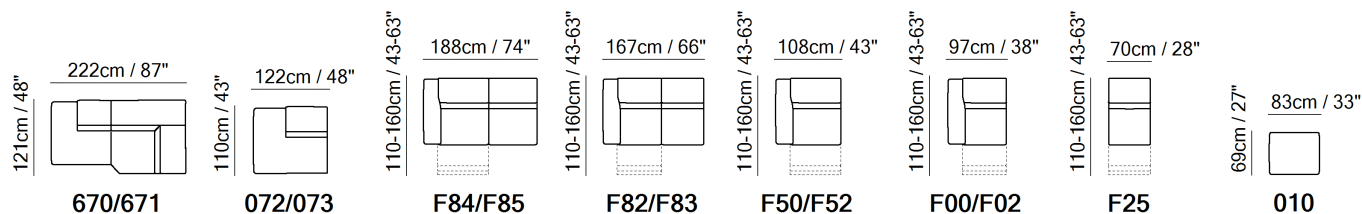
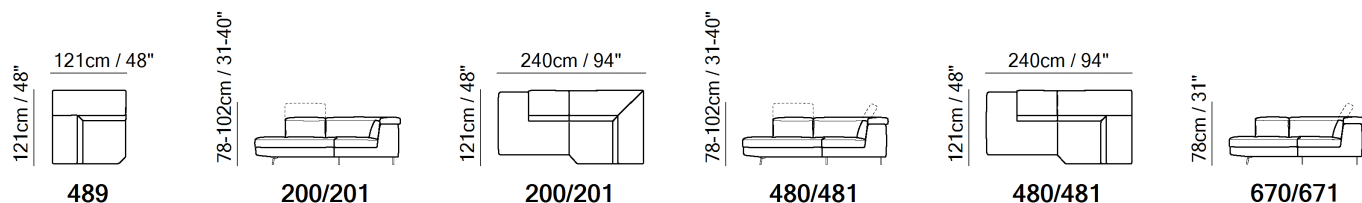
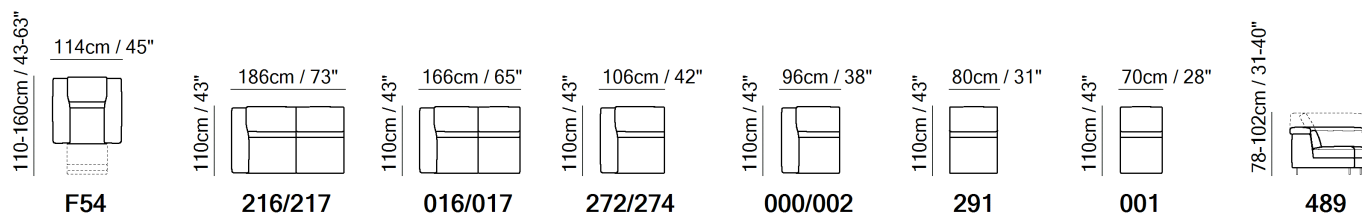
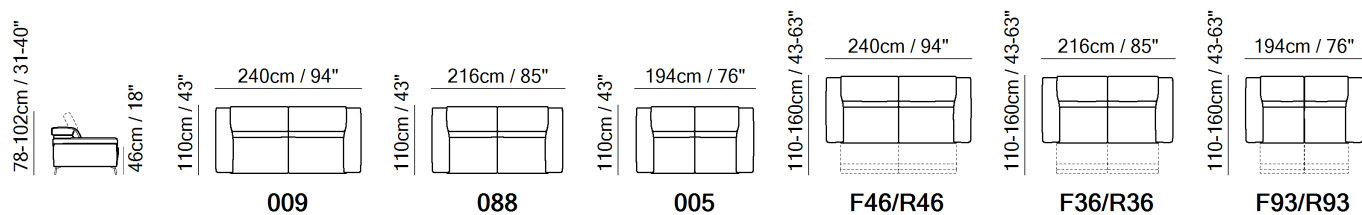

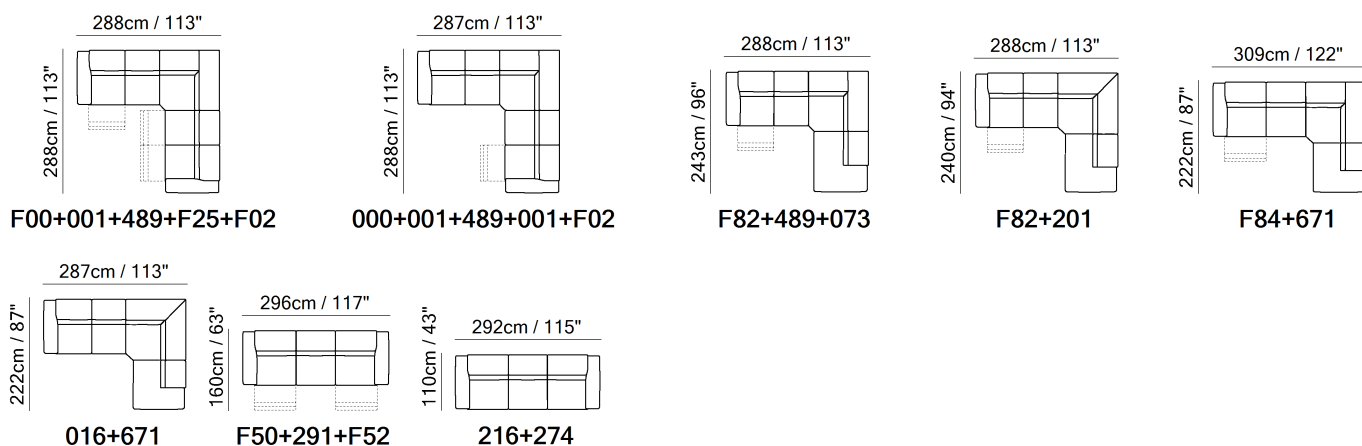

SCHEMATICS



COMPOSITION EXAMPLES



TECHNICAL INFORMATION

	COVERING	Leather <input checked="" type="checkbox"/>	Soft Cover <input checked="" type="checkbox"/>			
	FILLING	Arms <input type="checkbox"/> Fiber <input checked="" type="checkbox"/> Foam <input type="checkbox"/> Feather/Fiber Mix <input type="checkbox"/> Feather	Seat cushion <input type="checkbox"/> Fiber <input checked="" type="checkbox"/> Foam <input type="checkbox"/> Feather/Fiber Mix <input type="checkbox"/> Feather	Back cushion <input type="checkbox"/> Fiber <input checked="" type="checkbox"/> Foam <input type="checkbox"/> Feather/Fiber Mix <input type="checkbox"/> Feather		
	COMFORT	Firm Comfort <input type="checkbox"/>	Standard Comfort <input checked="" type="checkbox"/>			
	FUNCTION	Bed <input type="checkbox"/>	Electric motion <input type="checkbox"/>	Motion <input checked="" type="checkbox"/>	Recliner <input checked="" type="checkbox"/>	Sliding <input type="checkbox"/>
	VISUAL APPEARANCE*	Low <input checked="" type="checkbox"/>	Medium <input type="checkbox"/>	High <input type="checkbox"/>		
	LEGS	Wood <input type="checkbox"/>	Plastic <input type="checkbox"/>	Metal <input checked="" type="checkbox"/>	Upholstered <input type="checkbox"/>	Castors <input type="checkbox"/>

VISUAL APPEARANCE

The product may reveal various wrinkles due to the combination of Elasticity of the covering, characteristics of the interior construction and the design of the product.



Products with Visual Appearance listed as High or Medium would require higher degree of care, where seats and back cushions may require fluffing and plumping more often than Products with Visual Appearance listed as Low.

NOTES

- Available in leather (TG only) or fabric.
- Dual power mechanism with external switch on the side panel that activates recliner and headrest and includes an USB charging port
- A battery pack can be ordered with its own version code 830. For order entry please use XX for category and XXX for cover code. In order to optimize the duration of the battery, it is suggested to order one per each motion seat.
- Tight Seat Cushion (the seat cushions of the models are fixed to the frame)
- Tight Back Cushion (the back cushions of the models are fixed to the frame)
- No Leather Side (the sectional pieces have the side covered with lining and not leather)
- Internal wooden frame.
- Feet will be in a bag inside the package and requires assembling.
- Packaging: plastic wrap for stationary versions and cardboard box for motion versions
- Metal legs available with matt black (79) or metal gold (90) finishings
- Feet height 12,5 cm

NOTES
