



■ Vers. 155



■ Vers. 009



■ Vers. 272+076+291+F52



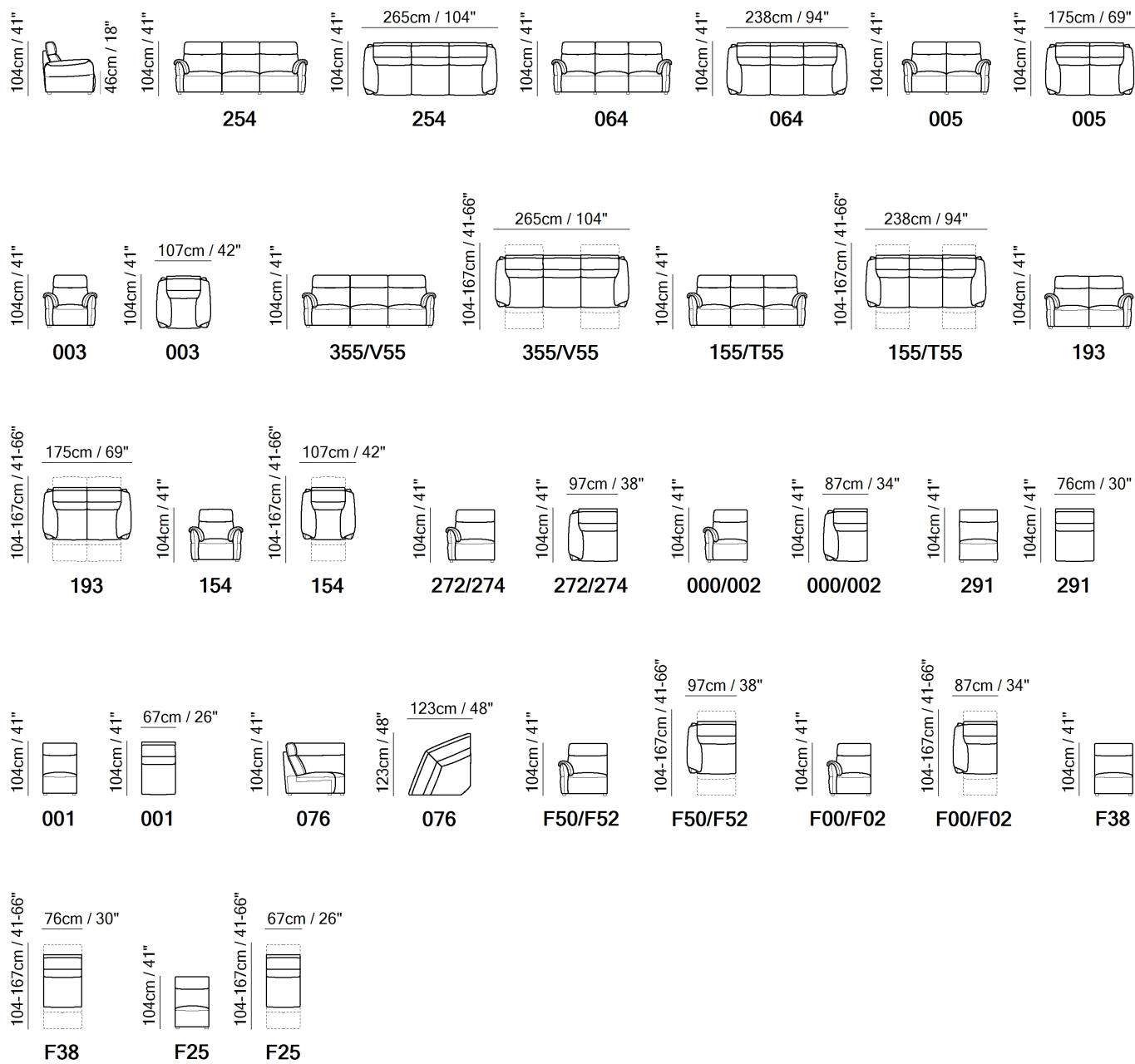

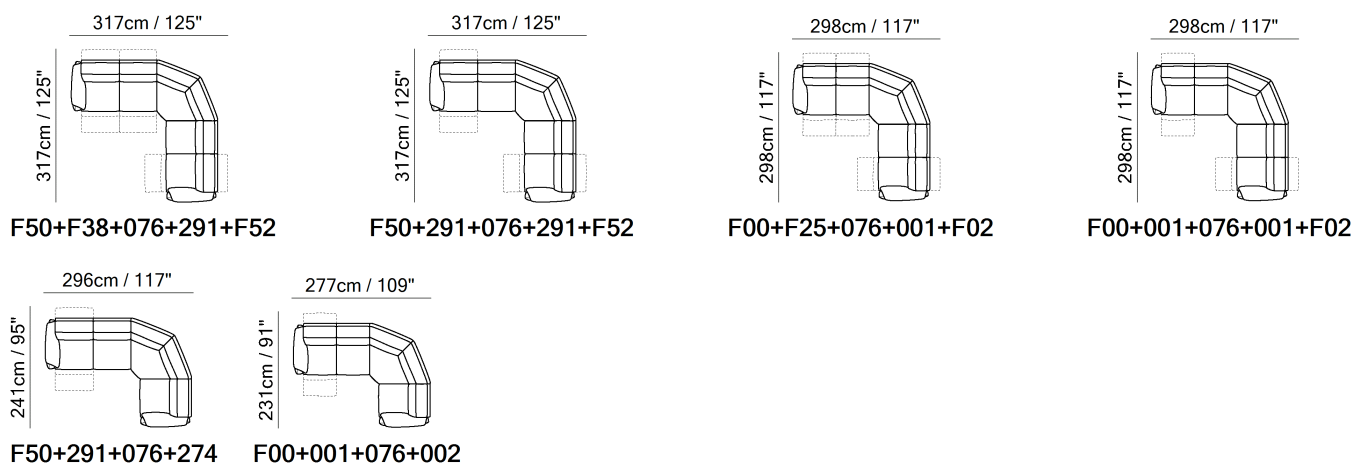

SCHEMATICS



COMPOSITION EXAMPLES



TECHNICAL INFORMATION

	<b>COVERING</b>	Leather <input checked="" type="checkbox"/>	Soft Cover <input checked="" type="checkbox"/>			
	<b>OPTIONS</b>	Removable <input type="checkbox"/>	Contrast Stitching <input type="checkbox"/>			
	<b>FILLING</b>	Arms <input type="checkbox"/> Fiber <input type="checkbox"/> Foam <input type="checkbox"/> Feather/Fiber Mix <input type="checkbox"/> Feather	Seat cushion <input type="checkbox"/> Fiber <input type="checkbox"/> Foam <input type="checkbox"/> Feather/Fiber Mix <input type="checkbox"/> Feather	Back cushion <input type="checkbox"/> Fiber <input type="checkbox"/> Foam <input type="checkbox"/> Feather/Fiber Mix <input type="checkbox"/> Feather		
	<b>COMFORT</b>	Standard Comfort <input checked="" type="checkbox"/>	Firm Comfort <input type="checkbox"/>			
	<b>FUNCTION</b>	Bed <input type="checkbox"/>	Electric motion <input checked="" type="checkbox"/>	Motion <input checked="" type="checkbox"/>	Recliner <input checked="" type="checkbox"/>	Sliding <input type="checkbox"/>
	<b>VISUAL APPEARANCE*</b>	Low <input type="checkbox"/>	Medium <input checked="" type="checkbox"/>	High <input type="checkbox"/>		
	<b>LEGS</b>	Wood <input type="checkbox"/>	Metal <input type="checkbox"/>	Plastic <input type="checkbox"/>	Castors <input type="checkbox"/>	Upholstered <input type="checkbox"/>

VISUAL APPEARANCE

The product may reveal various wrinkles due to the combination of Elasticity of the covering, characteristics of the interior construction and the design of the product.



Products with Visual Appearance listed as High or Medium would require higher degree of care, where seats and back cushions may require fluffing and plumping more often than Products with Visual Appearance listed as Low.

NOTES

- Available in leather or fabric.
- Ergocert Certified. Human-Centered Design certification by Ergocert, is the first European ergonomics certification body. This certification guarantees that the entire design and production process has been completed by listening to the needs of the end user to create and offer an effective and unique comfort experience.
- By distributing weight evenly across all pressure points, the zero-gravity power motion system makes you feel weightless. It takes the pressure off your spine and can promote circulation in the legs.  
The definition of Zero Gravity Reclining is the ability for your heart to be resting above your feet which provides proven health benefits.
- ZERO GRAVITY™ DUAL POWER MOTION: a unique power motion system that separately and independently activates the different functions, to adjust the seat recliner and the headrest, allowing you to reach extreme comfort in a “zero gravity” position.
- Switch #1: All in One Power Reclining mechanism that simultaneously reclines the back, activates a “comfort tilt” of the seat and a full extension of the footrest, taking you to a “zero gravity” position that will make you experience a total and unparalleled relaxation.
- Switch #2: Power Adjustable Headrest which allows you to recline the headrest forward with millimetric precision to support you with a perfect and proper posture.

## NOTES

---

- Functions are operated by the power switch located on outside panel of the arm which also allocates a USB charging port.
- Second option versions (355/V55/254) with three seats and three cushions have a wider seating vs standard versions (155/T55/064) resulting in a bigger configuration (265 cm/106" vs 238 cm/95,2")
- **PACKAGING & DELIVERY**  
This model has been designed in an innovative way to facilitate the delivery to the final consumer throughout separate packages that have sizes and weight that are easy to handle.
- In fact, on the 3-seater power motion sofa you will have a choice of preferred packaging:
  - > Versions T55 and V55 follow the above redesigned packing with 3 separate boxes (Arms / Seat and Base / Backrest) to maximize space in container as well as to facilitate the handling to final consumer.
  - > Versions 155 and 355 are packaged in 1 single box, that can facilitate warehouse management