

Model #

688c Hawthorne Office Chair

GAC = Glazed Antique Cherry finish

JAV = Java finish

PEC = Pecan finish

Assembly Instructions

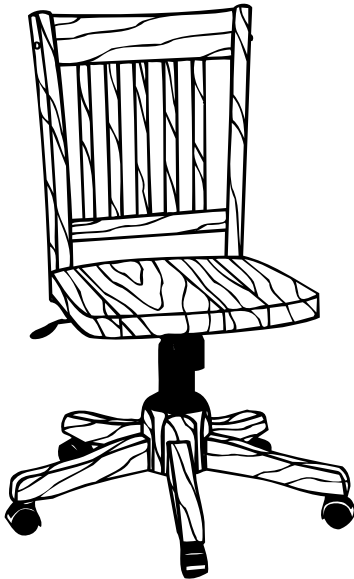

Thank you for allowing us to help you furnish your home. We are certain you will be delighted with your new furniture for many years to come.

IMPORTANT NOTES:

- For normal household use only. *Not* recommended for commercial use.
- Do not climb or stand on this piece of furniture.

WARNING

Drilling, sawing, sanding or machining wood products can expose you to wood dust, a substance known to the state of California to cause cancer. Avoid inhaling wood dust or use a dust mask or other safeguards for personal protection.

For more information go to: www.p65warnings.ca.gov/wood

This product can expose you to chemicals, including formaldehyde, which are known to the State of California to cause cancer.

For more information go to: www.p65warnings.ca.gov/furniture

DESIGN SUBJECT TO CHANGE WITHOUT NOTICE.

CUSTOMER SERVICE

If you ever have questions about your furniture, please do not hesitate to contact us. In the unlikely event you need a replacement part; we can make those parts available through an authorized Whittier Wood Furniture dealer. If you cannot order replacement parts through your dealer, please contact our customer service department.

Hours: Our friendly customer service staff can be reached:

Monday-Friday 8:00 a.m. to 5:00 p.m. (Pacific Time).

You may leave a message 24 hours a day, seven days a week.

Customer Service: 800-653-3336 • Outside the U.S.: 541-687-0213

Fax: 541-687-2060 • Email: info@whittierwood.com

**Whittier
Wood**
FURNITURE

P.O. Box 2827
Eugene, OR 97402 USA













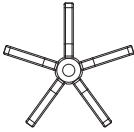

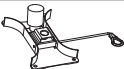
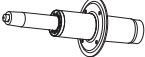



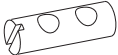

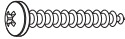

Production Code:

VN

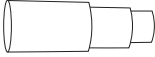
10/23

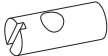
688c Hawthorne Office Chair — Parts List

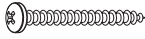
Please identify the parts and check that quantities received match those on this list.
If you need to replace a part, refer to the following letter and model name.

Part	Description	Quantity
Aa	Back Assembly 	1
F	Seat 	1
Gc	Pedestal Assembly (attached) 	1
GG	Pedestal 	1
H	Tilter Mechanism 	1
II	Gas Cylinder 	1
Jc	Foot (attached) 	5
Mb	Antique Brass Plate 	2
Nb	5/16" x 3-1/2" Barrel Bolt Antique Brass 	4
O	Double Barrel Nut 	2
Q	#10 x 1-1/4" Black Pan Head Screw 	4
R	#10 x 3/4" Pan Head Screw 	35 (15 inserted)
S	5/16" x 2-1/2" Hex Bolt (inserted) 	5
T	5/16" Washer (attached) 	5
U	3-1/4" Ring Sleeve (attached) 	1
Vc	Caster 	5
W	Large 5 Leg Star Plate (attached) 	1
X	Cylinder Cover (3 pieces) 	1
Y	#14 x 1" Philtruss Screw 	4
Z	5/16" Single Barrel Nut (inserted) 	5
ZA	3-1/4" Washer (attached) 	1
ZB	#8 x 1-1/4" Pan Head Screw (inserted) 	5
ZC	Z Hex Wrench 	1

688c Hawthorne Office Chair Assembly Instructions

Tools Required: Phillips Screwdriver; Slotted Screwdriver,
Rubber Mallet or Padded Hammer; Drill and 1/8" Drill Bit

Tools included: Z Hex Wrench

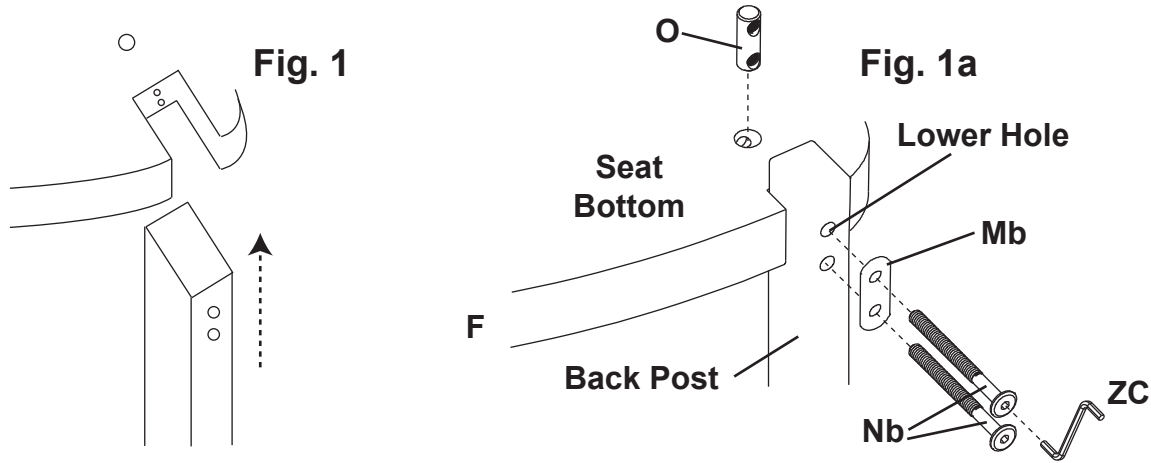

1. Place the Seat (F) upside-down on a clean protected surface. Slide the posts of the Back Assembly (Aa) into the notches in the back edge of the Seat until the holes in the post line up with the holes in the notches. **THE BACK POSTS WILL NOT FIT INTO THE NOTCHES IF YOU TRY TO PUSH THEM IN HORIZONTALLY.** See Figure 1. Place a Double Barrel Nut (O) into the hole in the bottom of the Seat. **NOTE: THE SLOTTED END OF THE DOUBLE BARREL NUT (O) IS PARALLEL TO THE THREADED HOLES IN THE BARREL. THIS WAY, YOU CAN CONTROL THE DIRECTION OF THE HOLES WITH A SLOTTED SCREWDRIVER.** Align the slot in the nut. Hold one Brass Plate (Mb) over the holes and insert a Barrel Bolt (Nb) into the lower hole in the edge of the back post of the Back Assembly. Start the threads into the Barrel Nut. See Figure 1a. Now start the other Barrel Bolt (Nb) through the Brass Plate and into the Barrel Nut. Use the Hex Wrench (ZC) to tighten the Barrel Bolts until snug. **NOTE: TO AVOID STRIPPING THE HEAD OF THE BOLT, BE SURE THE ALLEN WRENCH IS COMPLETELY SEATED.**

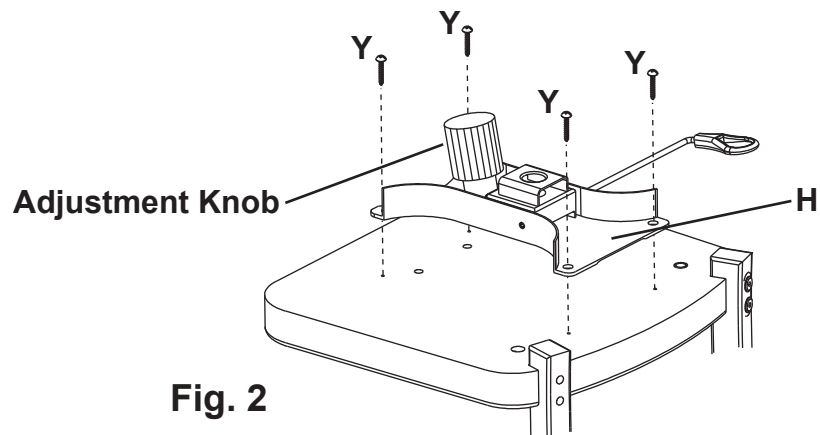

2. Turn the Tilter Mechanism (H) upside-down and place it on the bottom of the seat. Make sure the adjustment knob faces the front of the chair as shown in Figure 2. Match up the four small screw holes in the Tilter Mechanism with those in the bottom of the seat. Screw the mechanism in place with four #14 x 1" Philtruss Screws (Y).

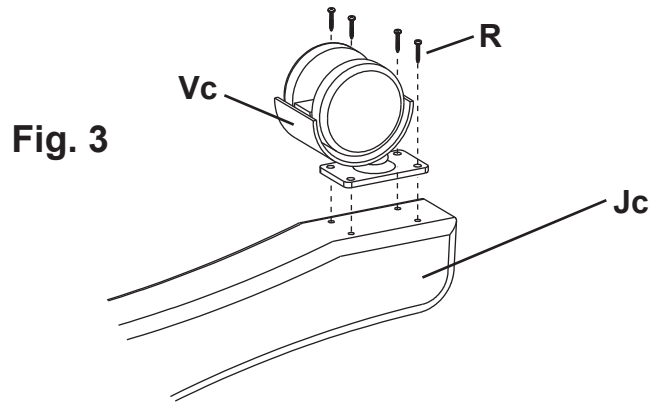

3. Place the Caster (Vc) over the prepunched holes in the bottom of the Foot (Jc). Screw the Caster down with four #10 x 3/4" Pan Head Screws (R). Repeat for the other three Feet. See Figure 3.

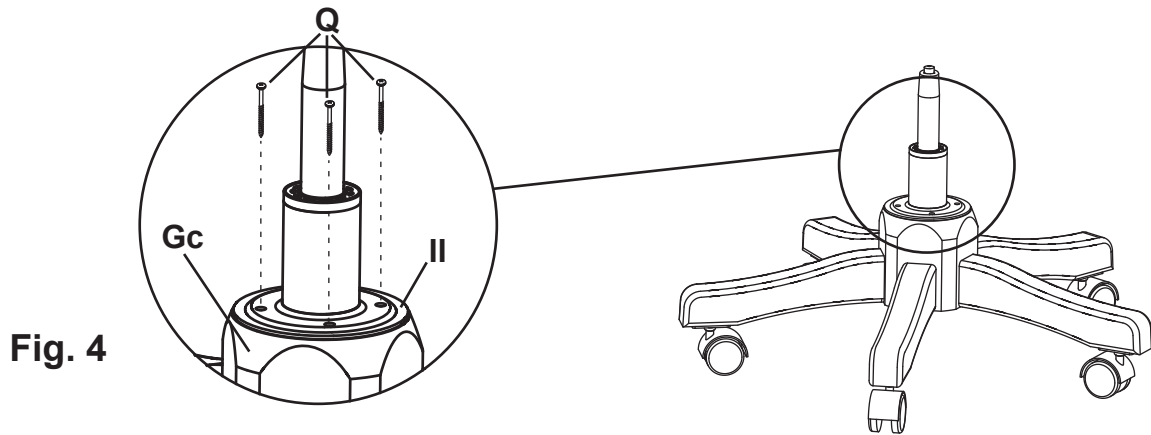

4. Insert the Gas Cylinder (II) into the Pedestal Assembly (Gc). The lip on the Cylinder may not sit flush against the top of the Pedestal. With a 1/8" drill bit, drill pilot holes 3/4" deep through the holes in the gas cylinder lip and into the Pedestal. Insert four #10 x 1-1/4" Black Pan Head Screws (Q) through the Gas Cylinder and into the Pedestal and securely fasten. This will draw the lip flush against the Pedestal. See Figure 4.

NOTE: The largest outer ring of the Cylinder Cover is not required and may be discarded if you choose not to use it.

Fig. 5

5. Place the Leg Assembly on the floor. Slip the Cylinder Cover (X) over the Gas Cylinder. The smaller upper section should lock on the cylinder. Lower the chair seat on to the Gas Cylinder so that the chrome section fits into the hole in the Tilter Mechanism (H). Sit in the chair to secure the fit. This will lock the Gas Cylinder to the Tilter Mechanism.

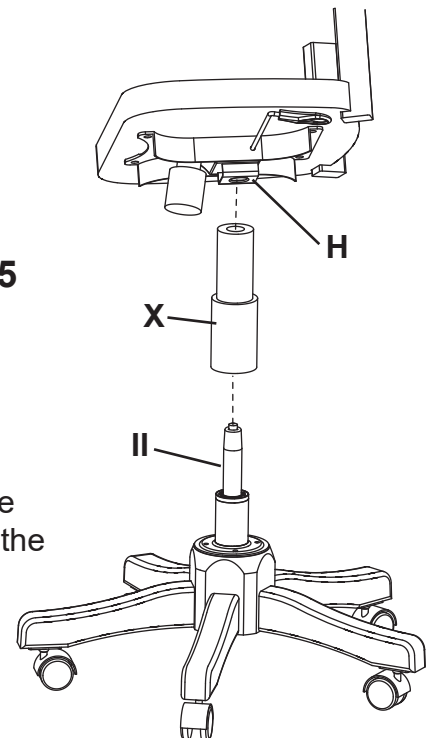

6. To adjust the seat height:

To lower the seat, sit in the chair and pull up on the lever on the Tilter Mechanism. Release the lever when the seat is low enough.

To raise the seat, pull up on the lever without weight on the seat.

7. To adjust the tilt tension:

Turn the Adjustment Knob clockwise to increase the tension.

Turn the knob counter-clockwise to loosen the tension.

to lock the tilt mechanism, push the lever in and it will prevent the chair from tilting.