

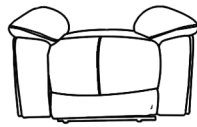
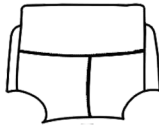

ASSEMBLY INSTRUCTION FOR ACME FURNITURE

MODEL# LV05872

Thank you for purchasing the quality product. Be sure to check all packing material carefully for small parts which may have come loose inside the carton during shipment. Separate, Identify and count all parts and metal hardware. Compare with all parts listed to be sure all parts are present. If any part(s) are missing or damaged, please contact your local furniture dealer. For efficient and speedy service, please indicate the model number and code letter of part(s) needed.

COMPONENT PARTS		
DESCRIPTION	PART NAME	Q'TY(PCS)
① Seat		1PC
② Backrest		1PC

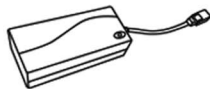
HARDWARE REQUIRED

Configuration	A: Transformer 	B: Power Line 
1E	1	1

Attention

***Some number parts listed on the instruction sheet may not be in parts bag as they may be assembled. Carefully check parts and packing materials prior to ordering replacements. ***

HOW TO ASSEMBLE:

STEP 1

Take out the electric parts from the bottom of the sofa, assemble them as right instruction. connect the line under recliner to the transformer directly.

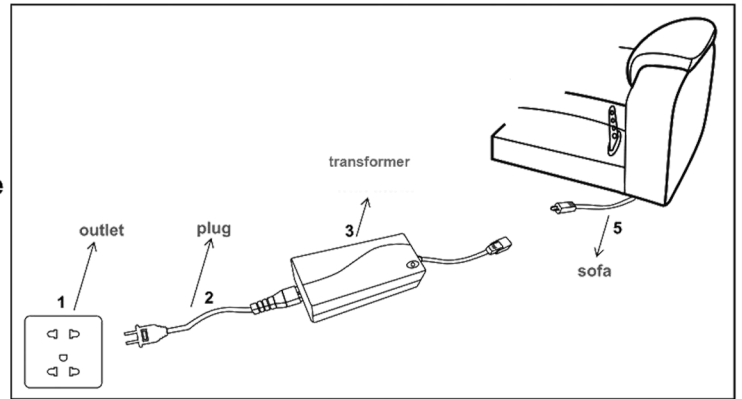

STEP 2

Join sofa by back connector

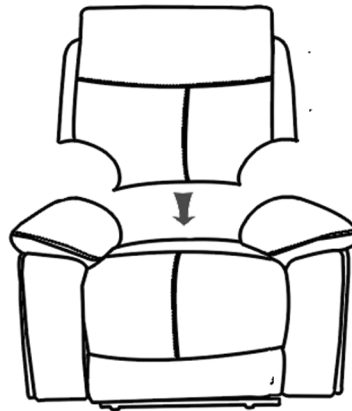
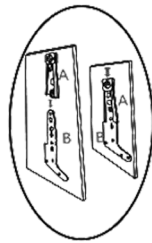

STEP 3

Assembly complete

This appliance is not intended for use by persons (including children) with reduced physical, sensory or mental capabilities, or lack of experience and knowledge, unless they have been given supervision or instruction concerning the use of the appliance by a person responsible for their safety. Children should be supervised to ensure that they do not play with the appliance.

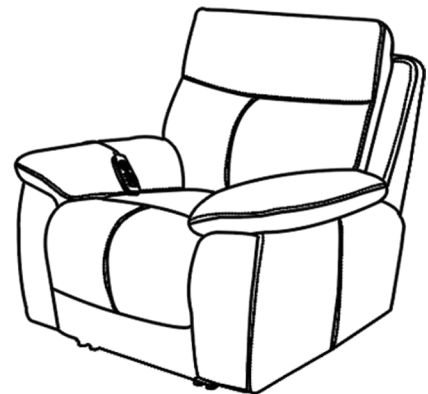

HOW TO USE CONTROL PANEL:

How to recline?

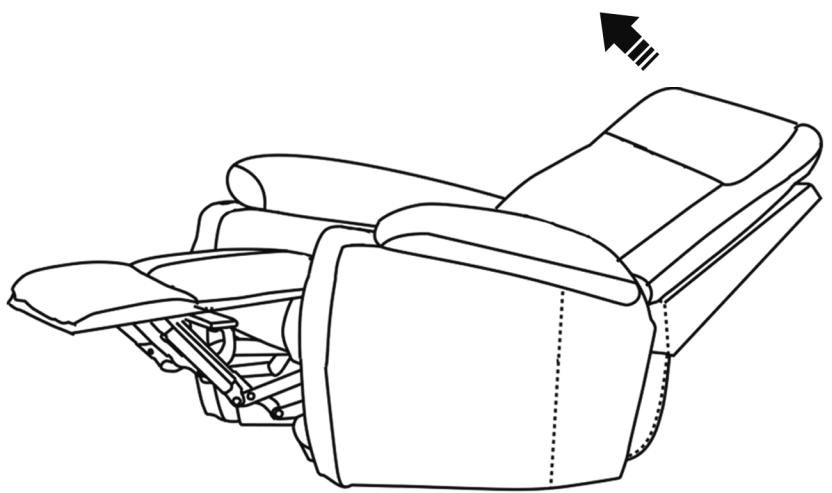
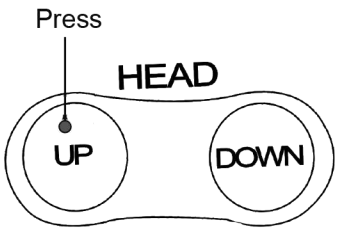
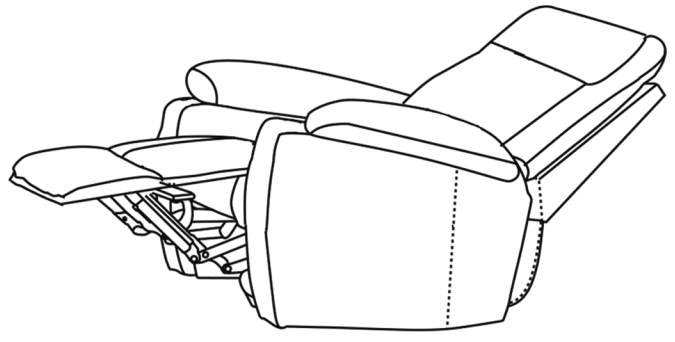
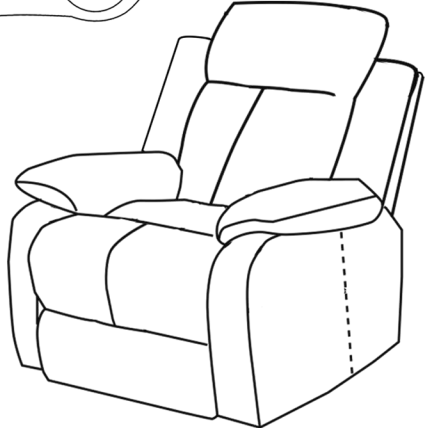
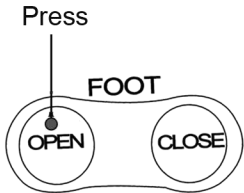

Button function:

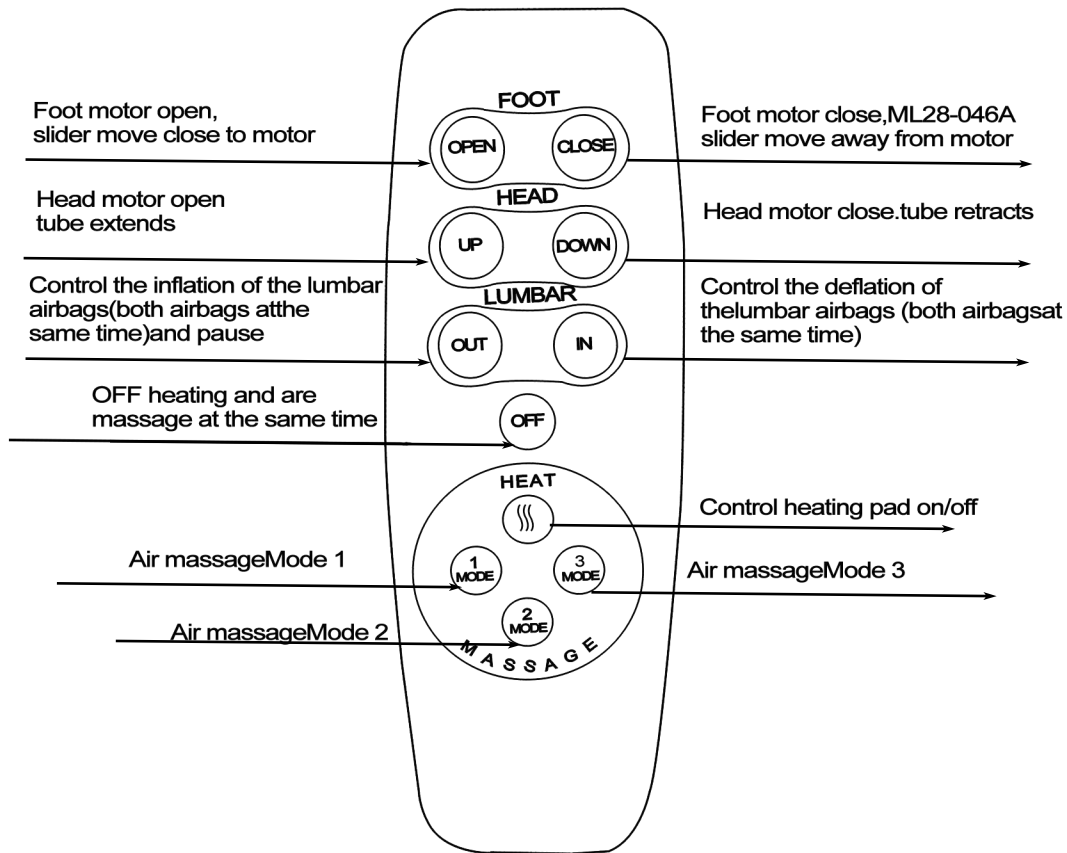

- (1) Press the button to control the foot motor, the slider moves close to the motor, release the slider to stop the motor; with white background light
- (2) Press the button to control the foot motor, the slider moves away from the motor, release the slider to stop the motor; with white background light
- (3) Press the button to control the head motor, the tube extends, release the button to stop the motor; with white background light
- (4) Press the button to control the head motor, the tube retracts, release the button to stop the motor; with white background light
- (5) Press the button to control the lumbar support airbag to inflate and pause with a white background light, and the inflation function has a 20s delay
- (6) Press the button to deflate the lumbar support airbag, and release it to stop deflation; with white background light.
- (7) Press the button to turn the heating pad on and off, with a red background light and a 20-minute timing function. The heating data is shown in Attachment 1
- (8) Indicates 3 airbag massage modes, with white background light and 20-minute timer; Airbag massage has a cycle pattern, see Attachment 1 for details.
- (9) After pressing the button, the heating and airbag massage functions are turned off, without background light.
- (10) USB load test (with white connector)
 1. When the product has no load current, the output voltage is 4.75V~5.25V;
 2. When the product increases the load by 2A, the output voltage is 4.75V~5.25V;
 3. Current limiting protection: the load current should be within the range of 2.5±0.3A;

Attachment 1:

Heating data:

Mode	Voltage (V)	Current (A)
High	10±20% (8~12)	0.9±20%(0.7~1.1)
Middle	7.8±20% (6.2~9.3)	0.6±20%(0.5~0.7)
Low	4±20% (3.2~4.8)	0.4±20%(0.30~0.5)
Note: Power supply, voltage tolerance ±20%		

Data after heating and depressurization:

Mode	Voltage (V)	Current (A)
High	7.2±20% (5.6~7.2)	0.6±20%(0.5~0.7)
Middle	4.8±20% (3.7~4.8)	0.4±20%(0.30~0.5)
Low	2.4±20% (1.8~2.4)	0.3±20%(0.1~0.3)
Note: Power supply, voltage tolerance ±20%		

Attachment 2:

Action 1	Air bag 1	Air bag 2
①	↑ Inflation	↑ Inflation
	3 seconds later	
②	↓ deflation	↓ deflation
	Execute actions 1 to 2 N times	
Action 2	Air bag 1	Air bag 2
	Continue to inflate and deflate 10 times	↓ deflation
①	No interval time	
②	↓ deflation	Continue to inflate and deflate 10 times
	Execute actions 1 to 2 N times	
Action 3	Air bag 1	Air bag 2
①	↑ Inflation	No Action
	3 seconds later	
②	↑ Hold	↑ Inflation
	3 seconds later	
③	↓ deflation	Hold
	3 seconds later	
④	No Action	↓ deflation
	Execute actions 1 to 4 N times	