









ASSEMBLY INSTRUCTIONS FOR ACME FURNITURE

MODEL: LV03821

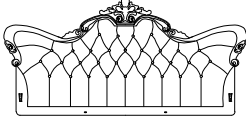
Thank you for purchasing the quality product. Be sure to check all packing material carefully for small parts which may have come loose inside the carton during shipment. Separate, Identify and count all parts and metal hardware. Compare with all parts listed to be sure all parts are present. If any part(s) are missing or damaged, please contact your local furniture dealer. For efficient and speedy service, please indicate the model number and code letter of part(s) needed.

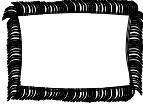
****Do not fully tighten screws until fully assembled****

| COMPONENT PARTS | | | |
|-----------------|--------------------|---|----------|
| NO. | DESC. | SKETCH | QUANTITY |
| A | SEAT FRAME |  | 1 PC |
| B | LEFT ARM |  | 1 PC |
| C | RIGHT ARM |  | 1 PC |
| D | SEAT CUSHION |  | 1 PC |
| E | BACKREST |  | 1 PC |
| U | KIDNEY PILLOW |  | 1 PC |
| F | LEG |  | 2 PCS |
| O | BIG SQUARE PILLOWS |  | 2 PCS |

| HARDWARE REQUIRED | | | |
|-------------------|---------------------|---|------|
| 1 | ALLEN KEY (5MM-RBW) |  | 1 PC |
| 2 | WRENCH |  | 1 PC |







Attention

***Some number parts listed on the instruction sheet may not be in parts bag as they may be assembled. Carefully check parts and packing materials prior to ordering replacements. ***

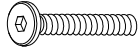
ASSEMBLY INSTRUCTIONS FOR ACME FURNITURE

MODEL: LV03821

HARDWARE REQUIRED

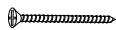
| | | | |
|---|-----------------------------|---|--------|
| 3 | BOLT (Ø5/16x2 ") |  | 4 PCS |
| 4 | BOLT (Ø5/16x3 1/4 ") |  | 6 PCS |
| 5 | THREAD BOLT (Ø5/16X3 1/4 ") |  | 2 PCS |
| 6 | HEX NUT (Ø5/16") |  | 2 PCS |
| 7 | FLAT WASHER (Ø5/16*22mm) |  | 12 PCS |
| 8 | LOCK WASHER (Ø5/16) |  | 12 PCS |
| 9 | SCREW (M4x2"3/4) |  | 4 PCS |

*How to assemble:

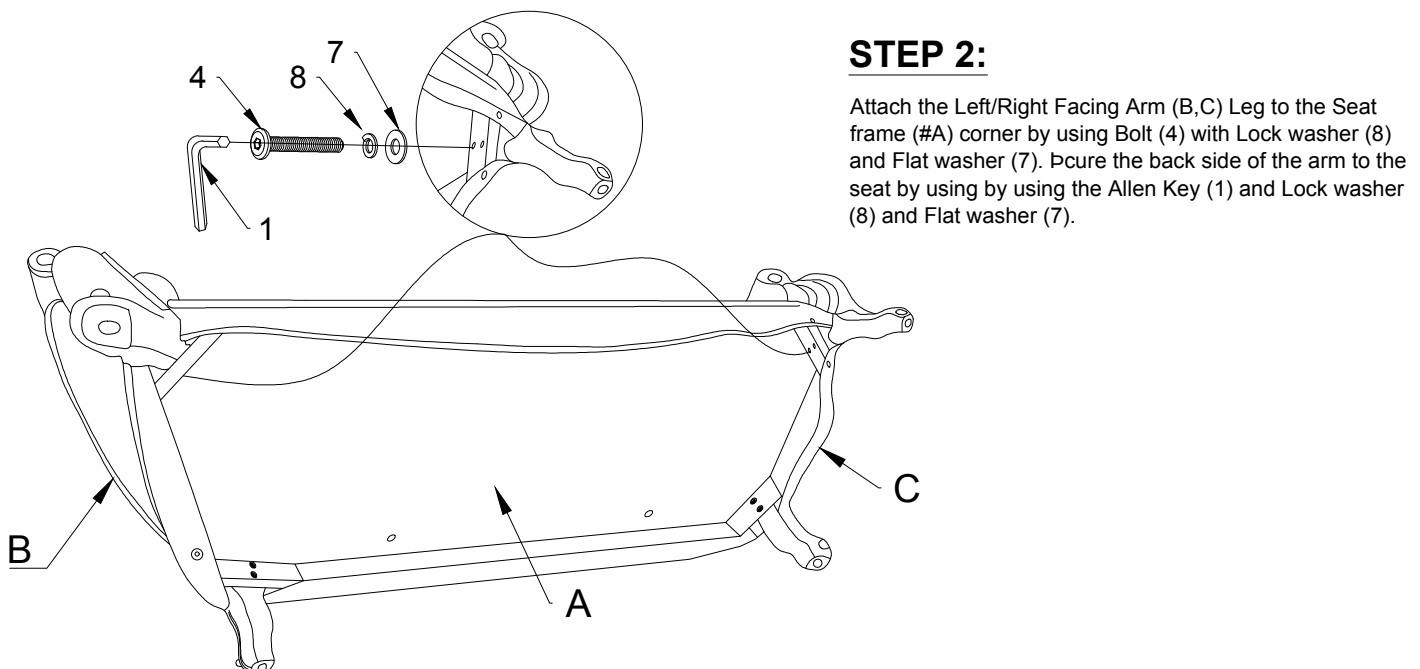
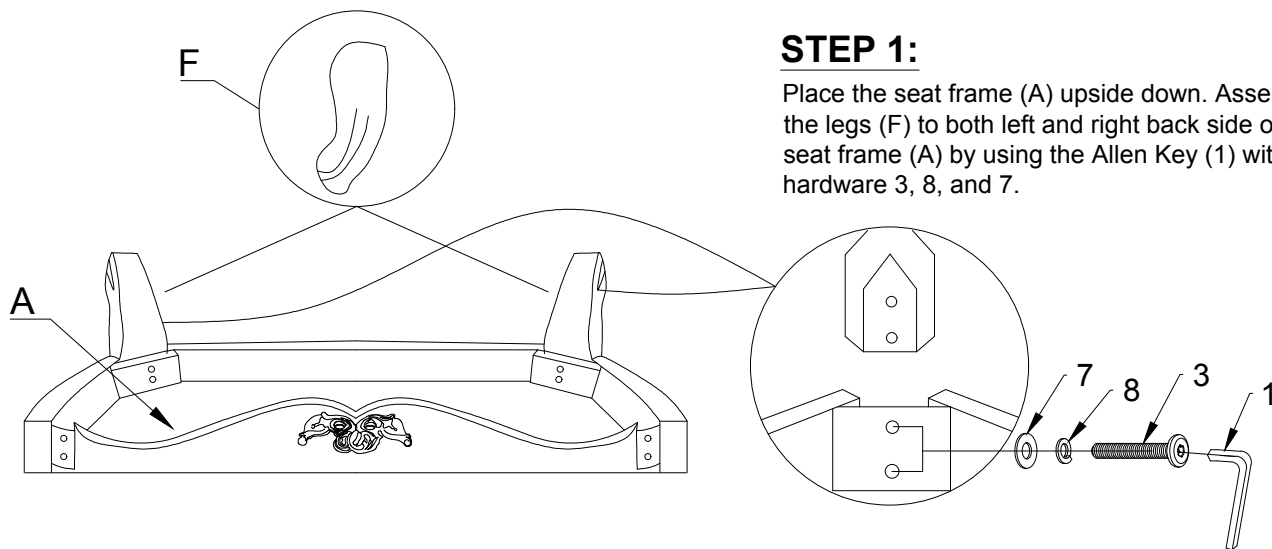

ASSEMBLY INSTRUCTIONS FOR ACME FURNITURE

MODEL: LV03821

STEP 3:

Align and attach Left arm (B) and Right arm (C) to the seat frame (A) using bolt (4) with washer (8) and flat washer (7) and securing with Allen Key (1).

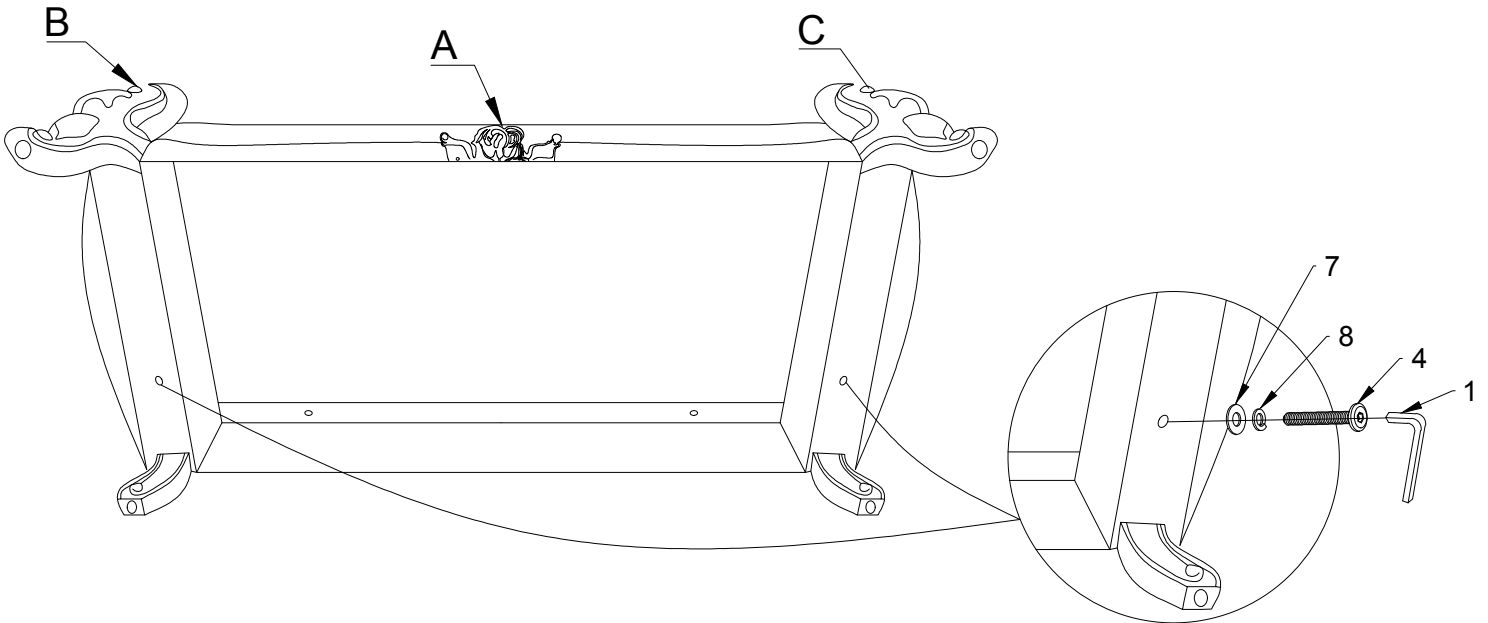

STEP 4:

Flip the bottom of the chair on, screw securing with screwdriver.

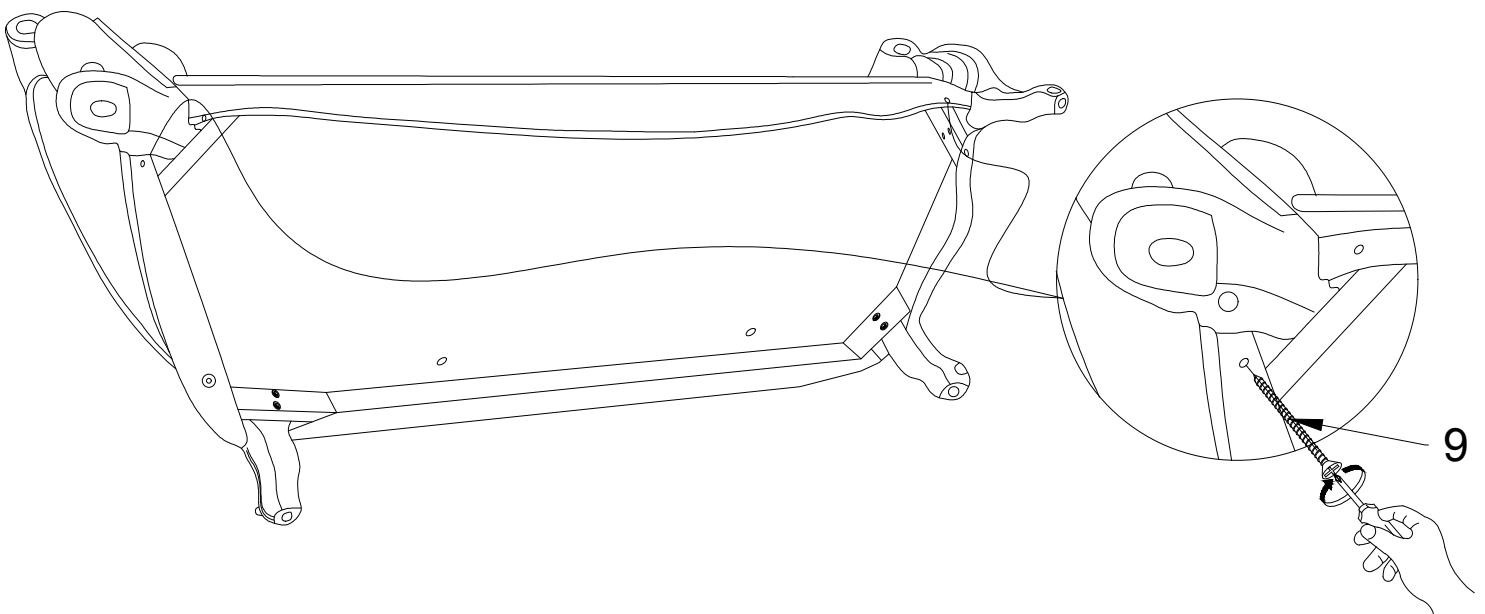

ASSEMBLY INSTRUCTIONS FOR ACME FURNITURE

MODEL: LV03821

STEP 5:

Place the backrest (E) mits bottom. Install the thread bolt (5) into the hole on the bottom of the backrest (E) by using your hands to rotate the bolt about 25 mm into the backrest (E).

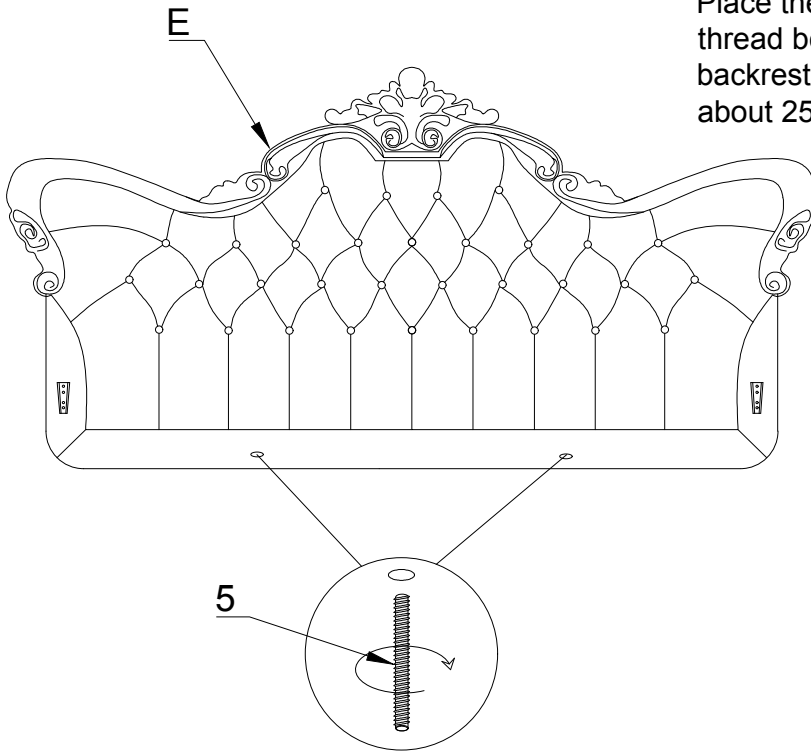

STEP 5:

Attach Backrest (E) to the Left arm (B) and Right arm (C) by sliding in the backrest all the way until it is secured and using bolt (5) with washer (8) and flat washer (7) and hex nut (6) securing with wrench (2).

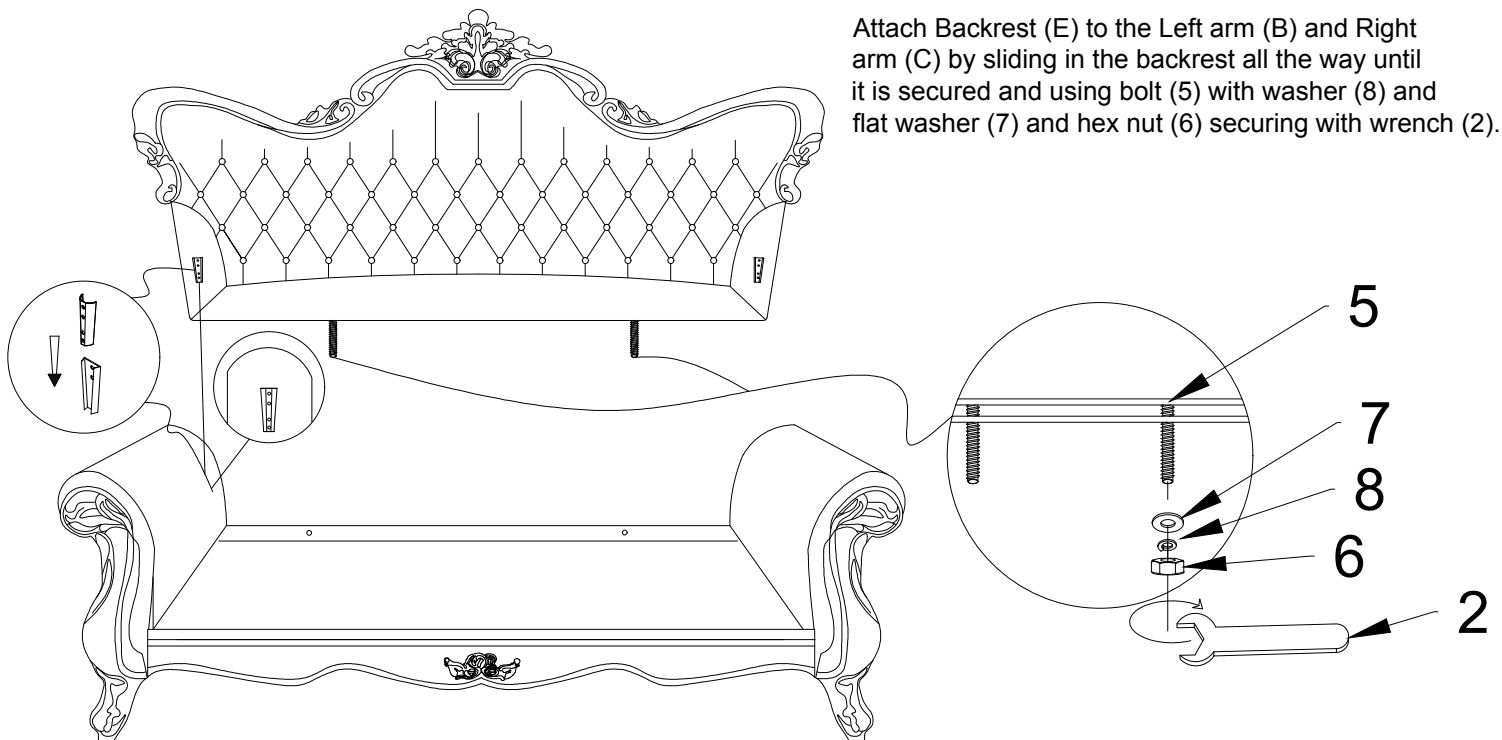

ASSEMBLY INSTRUCTIONS FOR ACME FURNITURE

MODEL: LV03821

STEP 7:

Place the seat cushion (D) on to the seat frame (A).

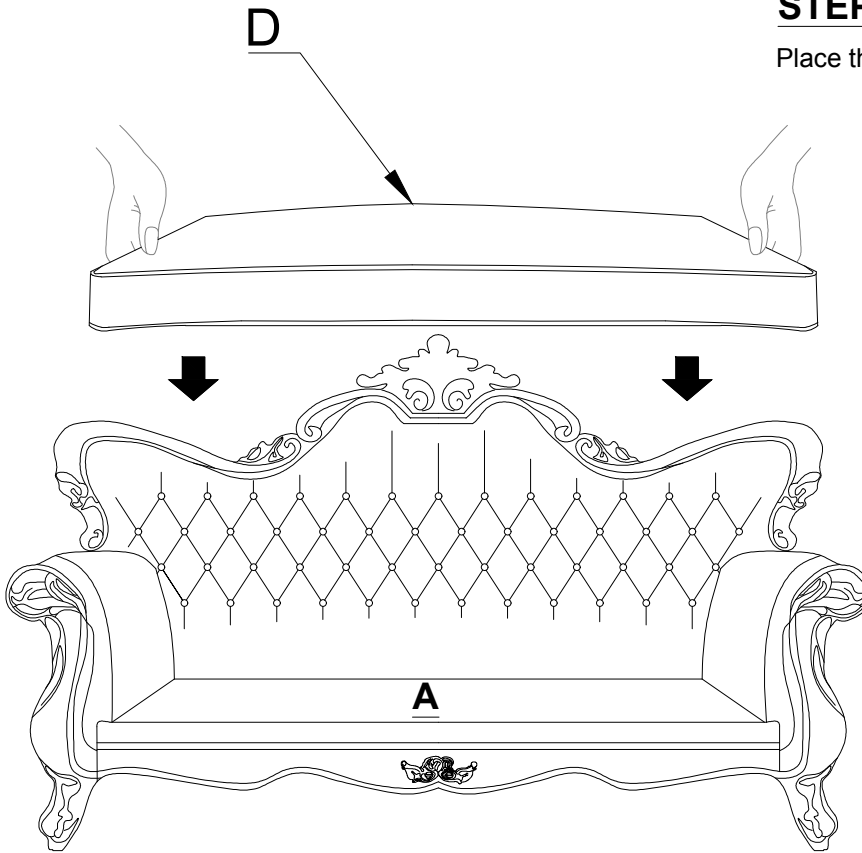

COMPLETE :

Your product is ready for you to enjoy.

