

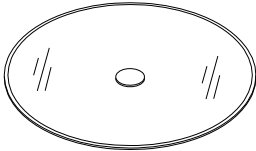









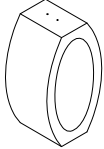

ASSEMBLY INSTRUCTION FOR ACME FURNITURE

MODEL# DN03175 DINING TABLE

Thank you for purchasing this quality product. Be sure to check all packing materials carefully for small parts which may have come loose inside the carton during shipment. Separate, identify, and count all parts and metal hardware. Compare with parts list to be sure all parts are present. If any part(s) are missing or damaged, please contact your local furniture dealer. For efficient and speedy service, please indicate the model number and code letter of the part(s) needed.

***** Do not fully tighten screws until fully assembled *****

COMPONENT PARTS		
DECERPTION	PART NAME	Q'TY(PCS)
①	Glass Top 	1pc
②	Base 	1pc
③	Pedestal 	1pc

HARDWARE REQUIRED:	
(A) 	Bolt 1/4"x1-5/8" - 4pcs
(B) 	Rod 5/16"x2-3/8" - 2pcs
(C) 	Washer $\phi 18 \times \phi 9 \times 2.0$ - 4pcs
(D) 	Allen Wrench M4 - 1pc
(E) 	Adjustable Foot - 6pcs
(F) 	Socket Wrench M8 - 1pc
(G) 	Nut M8 - 2pcs
(H) 	Washer $\phi 20 \times \phi 10 \times 1.5$ - 2pcs
(I) 	Cover - 2pcs

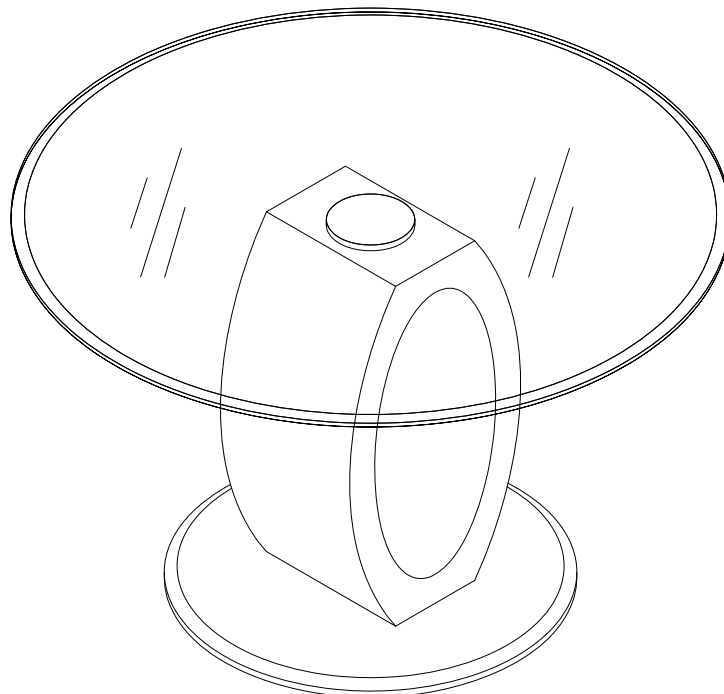

Attention:

***Mattresses not included.

***Some number parts listed on the instruction sheet may not be in parts bag as they may already be assemble.
Carefully check parts and packing materials prior to ordering replacements.

How to Assemble:

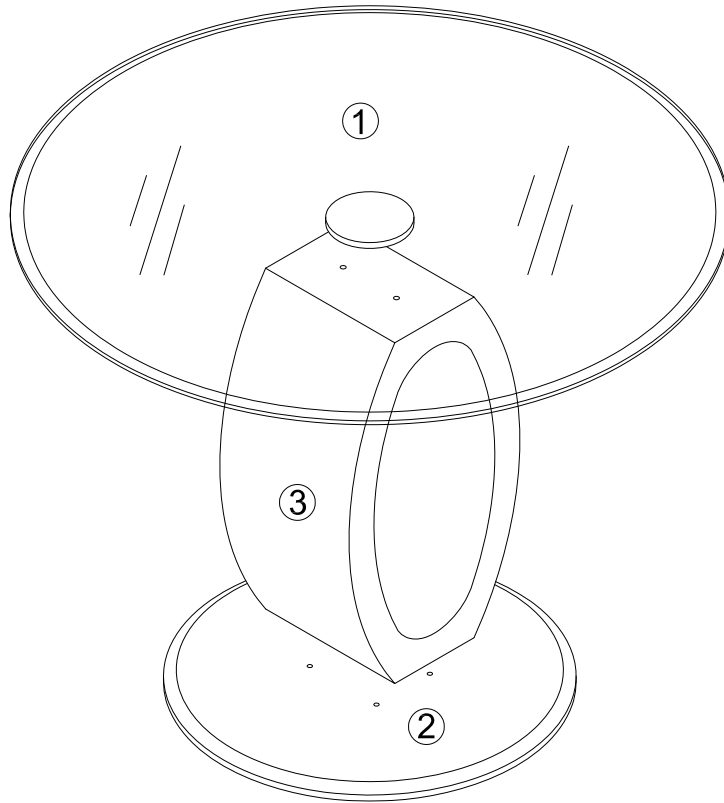

STEP 1.

Exploded View

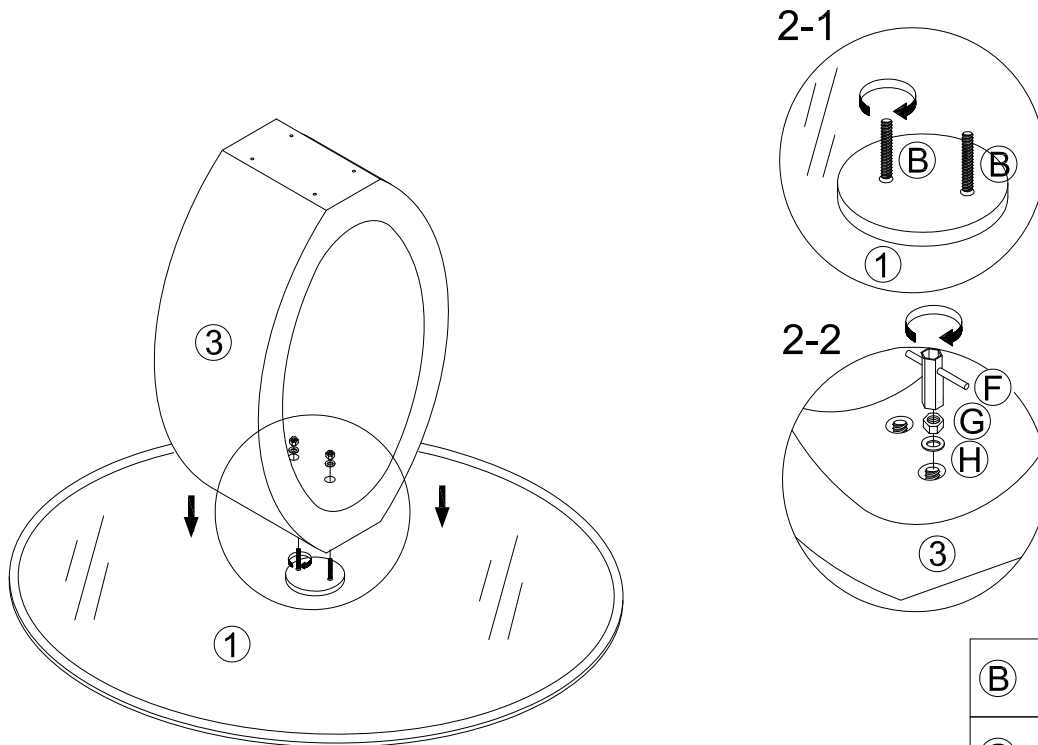

STEP 2.





(B)		2pcs
(G)		2pcs
(H)		2pcs

How to Assemble:

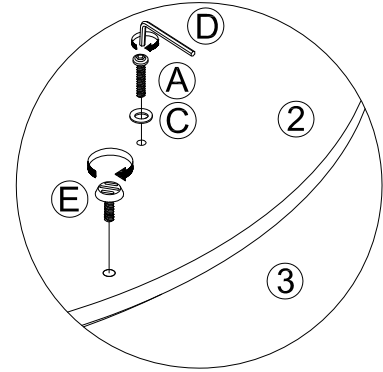
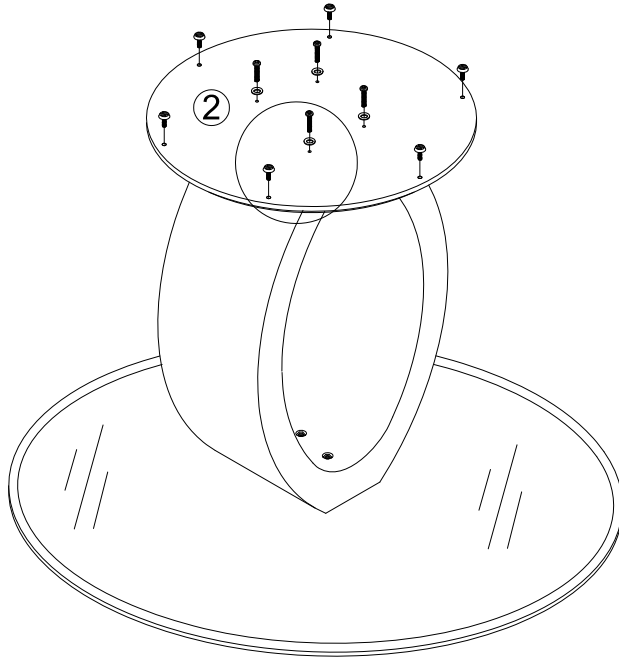
STEP 3.



(A)		4pcs
(C)		4pcs
(E)		6pcs

STEP 4.

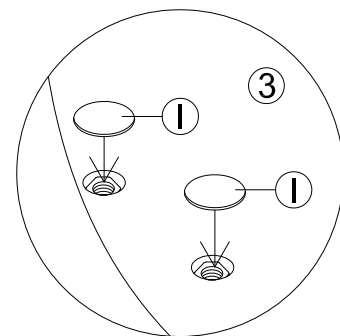
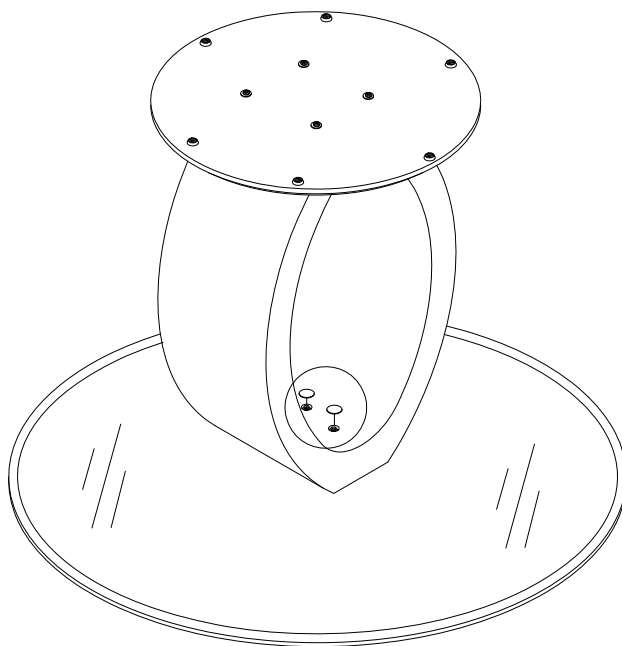

(I)		2pcs
-----	---	------